

南京诺金电气有限公司

Nanjing Nowking Electric Co., Ltd

抗震线环样本

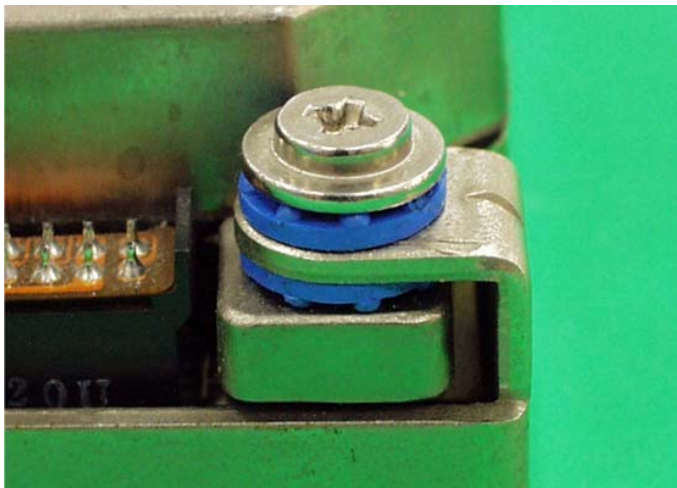

产品名称：抗震线环

规格型号：LTGM01

◆ MATERIAL: TPE

◆ COLOR: BLACK, BLUE, PURPLE, YELLOW

◆ UNIT: mm

用途：用于硬盘及精密零件之防震。

H: 为 55 度硬度 G: 为 45 度硬度.

LTGM01 结构图

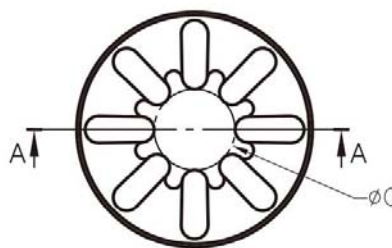
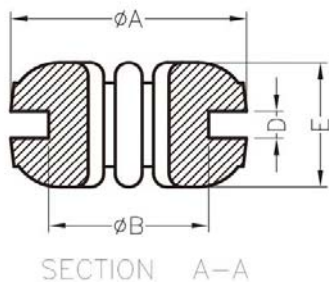

PART NO	A	B	C	D	E	PACKAGE
LTGM01	Ø14.0	Ø9.5	Ø4.85	1.6	8.1	1000

总机/TEL: +86 25 85437901 85422485 85436028
[Http://www.nowking.com](http://www.nowking.com) E-mail: nk@nowking.com
 QQ: 260678075 WeChat: 13770725488

南京诺金电气有限公司

Nanjing Nowking Electric Co., Ltd

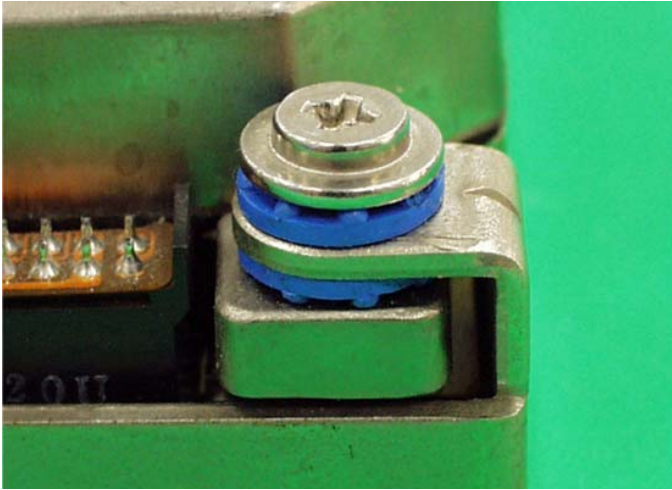

产品名称：抗震线环

规格型号：LTGM02

◆ MATERIAL: TPE

◆ COLOR: BLACK, BLUE, PURPLE, YELLOW

◆ UNIT: mm

用途：用于硬盘及精密零件之防震。

H: 为 55 度硬度 G: 为 45 度硬度.

LTGM02 结构图

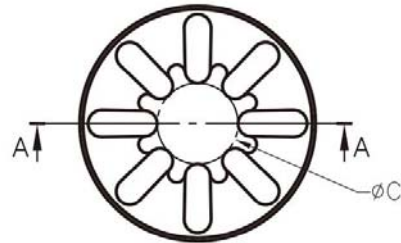
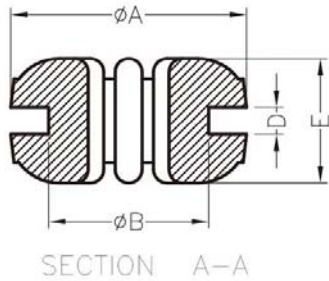

PART NO	A	B	C	D	E	PACKAGE
LTGM02	Ø14.0	Ø11.0	Ø4.85	1.6	8.1	1000

南京诺金电气有限公司

Nanjing Nowking Electric Co., Ltd

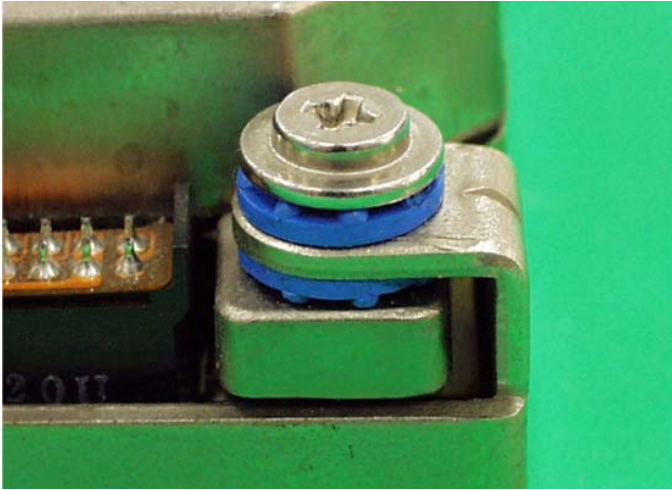

产品名称：抗震线环

规格型号：LTGM03

◆ MATERIAL: TPE

◆ COLOR: BLACK, BLUE, PURPLE, YELLOW

◆ UNIT: mm

用途：用于硬盘及精密零件之防震。

H: 为 55 度硬度 G: 为 45 度硬度.

LTGM03 结构图

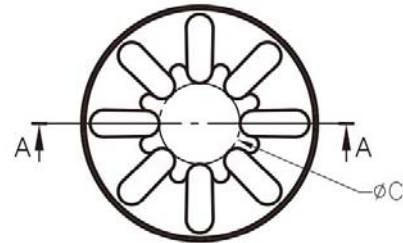
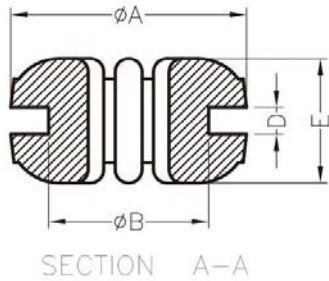

PART NO	A	B	C	D	E	PACKAGE
LTGM03	Ø14.0	Ø9.5	Ø4.85	1.0	7.5	1000

总机/TEL: +86 25 85437901 85422485 85436028
[Http://www.nowking.com](http://www.nowking.com) E-mail: nk@nowking.com
 QQ: 260678075 WeChat: 13770725488

南京诺金电气有限公司

Nanjing Nowking Electric Co., Ltd

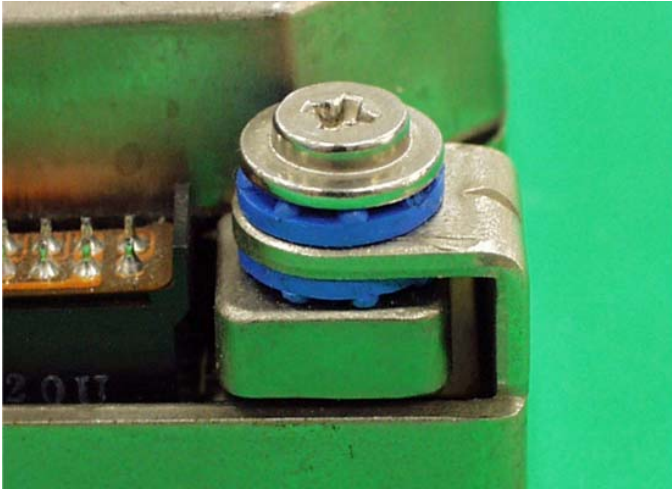

产品名称：抗震线环

规格型号：LTGM04

◆ MATERIAL: TPE

◆ COLOR: BLACK, BLUE, PURPLE, YELLOW

◆ UNIT: mm

用途：用于硬盘及精密零件之防震。

H: 为 55 度硬度 G: 为 45 度硬度.

LTGM04 结构图

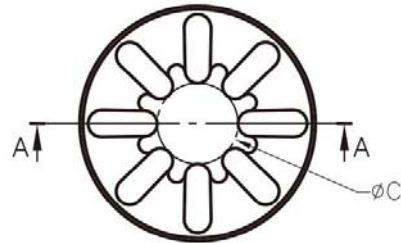
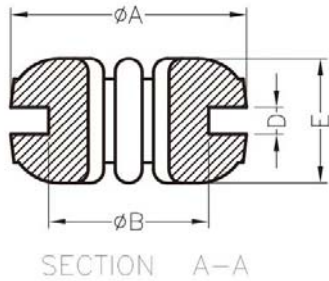

PART NO	A	B	C	D	E	PACKAGE
LTGM04	Ø14.0	Ø9.5	Ø4.85	1.0	8.1	1000

南京诺金电气有限公司

Nanjing Nowking Electric Co., Ltd

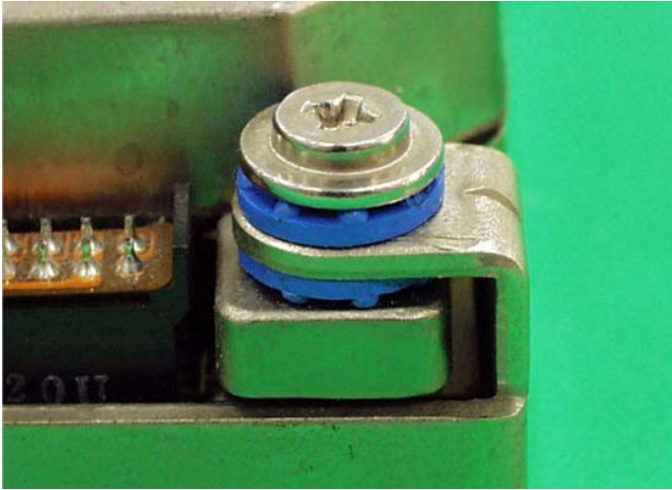

产品名称：抗震线环

规格型号：LTGM05

◆ MATERIAL: TPE

◆ COLOR: BLACK, BLUE, PURPLE, YELLOW

◆ UNIT: mm

用途：用于硬盘及精密零件之防震。

H: 为 55 度硬度 G: 为 45 度硬度.

LTGM05 结构图

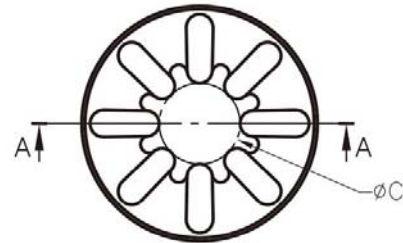
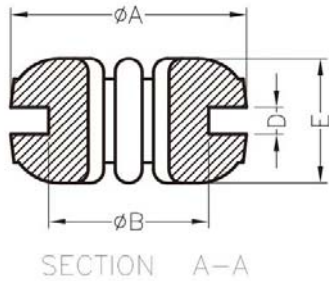

PART NO	A	B	C	D	E	PACKAGE
LTGM05	Ø14.0	Ø9.5	Ø4.85	1.2	7.4	1000

南京诺金电气有限公司

Nanjing Nowking Electric Co., Ltd

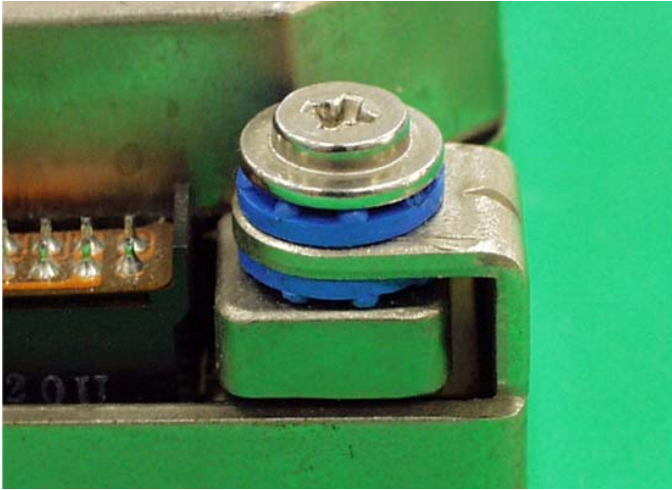

产品名称：抗震线环

规格型号：LTGM06

◆ MATERIAL: TPE

◆ COLOR: BLACK, BLUE, PURPLE, YELLOW

◆ UNIT: mm

用途：用于硬盘及精密零件之防震。

H: 为 55 度硬度 G: 为 45 度硬度.

LTGM06 结构图

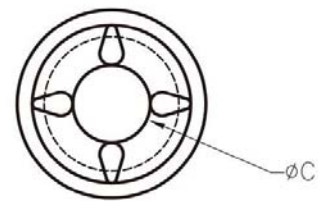
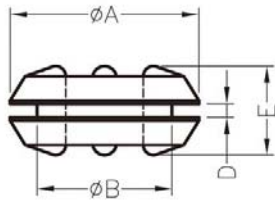

PART NO	A	B	C	D	E	PACKAGE
LTGM06	11.2	8.0	4.6	0.8	5.3	1000

南京诺金电气有限公司

Nanjing Nowking Electric Co., Ltd

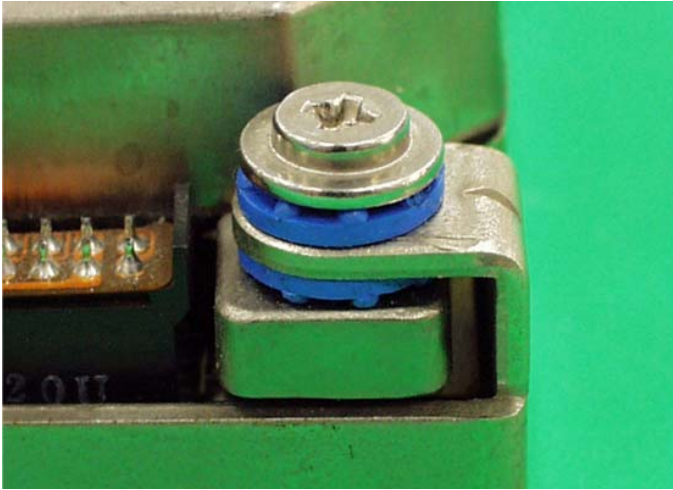

产品名称：抗震线环

规格型号：LTGM07

◆ MATERIAL: TPE

◆ COLOR: BLACK, BLUE, PURPLE, YELLOW

◆ UNIT: mm

用途：用于硬盘及精密零件之防震。

H: 为 55 度硬度 G: 为 45 度硬度.

LTGM07 结构图

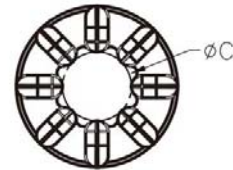
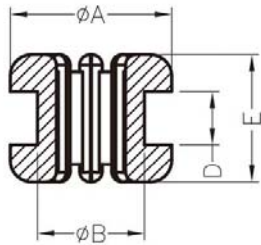

PART NO	A	B	C	D	E	PACKAGE
LTGM07	9.58	6.35	4.1	3.18	7.58	1000

南京诺金电气有限公司

Nanjing Nowking Electric Co., Ltd

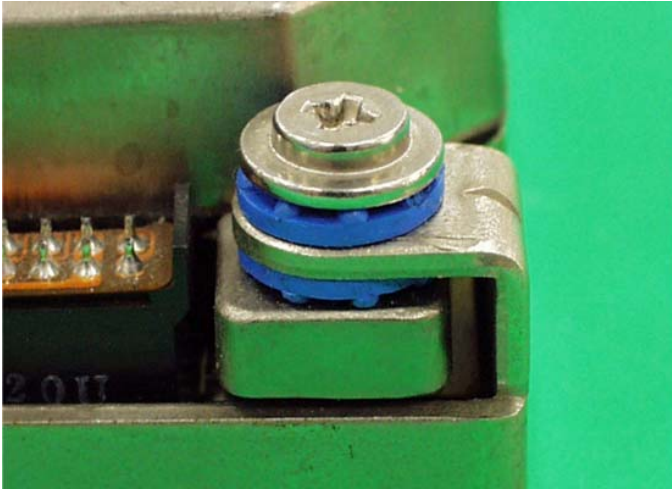

产品名称：抗震线环

规格型号：LTGM08

◆ MATERIAL: TPE

◆ COLOR: BLACK, BLUE, PURPLE, YELLOW

◆ UNIT: mm

用途：用于硬盘及精密零件之防震。

H: 为 55 度硬度 G: 为 45 度硬度.

LTGM08 结构图

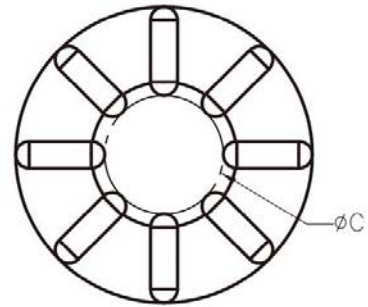
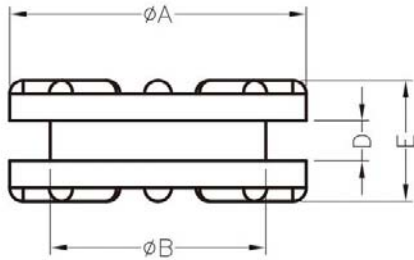

PART NO	A	B	C	D	E	PACKAGE
LTGM08	11.0	8.0	4.4	1.5	4.5	1000

南京诺金电气有限公司

Nanjing Nowking Electric Co., Ltd

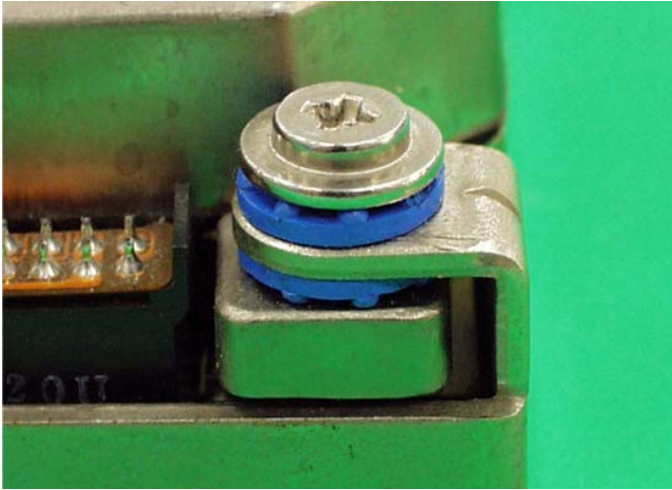

产品名称：抗震线环

规格型号：LTGM09

◆ MATERIAL:TPE

◆ COLOR:BLACK,

◆ UNIT: mm

用途：用于硬盘及精密零件之防震。

H:为 55 度硬度 G:为 45 度硬度.

LTGM09 结构图

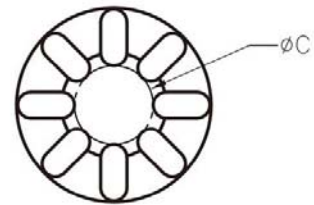
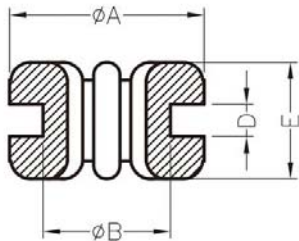

PART NO	A	B	C	D	E	PACKAGE
LTGM09	Ø9.62	Ø6.3	Ø3.9	1.0	5.8	1000

南京诺金电气有限公司

Nanjing Nowking Electric Co., Ltd

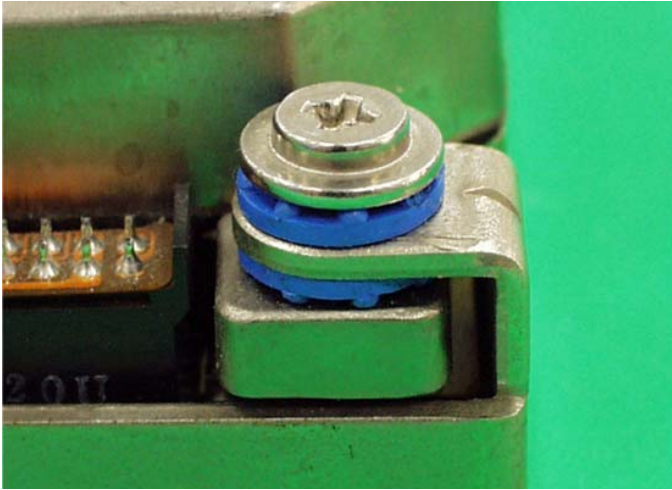

产品名称：抗震线环

规格型号：LTGM10

◆ MATERIAL:TPE

◆ COLOR:BLACK,

◆ UNIT: mm

用途：用于硬盘及精密零件之防震。

H:为 55 度硬度 G:为 45 度硬度.

LTGM10 结构图

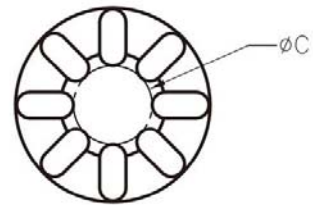
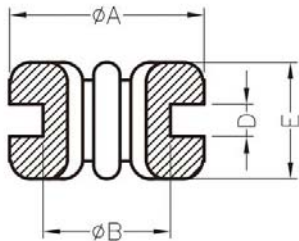

PART NO	A	B	C	D	E	PACKAGE
LTGM10	Ø9.62	Ø6.35	Ø3.9	0.8	5.8	1000

南京诺金电气有限公司

Nanjing Nowking Electric Co., Ltd

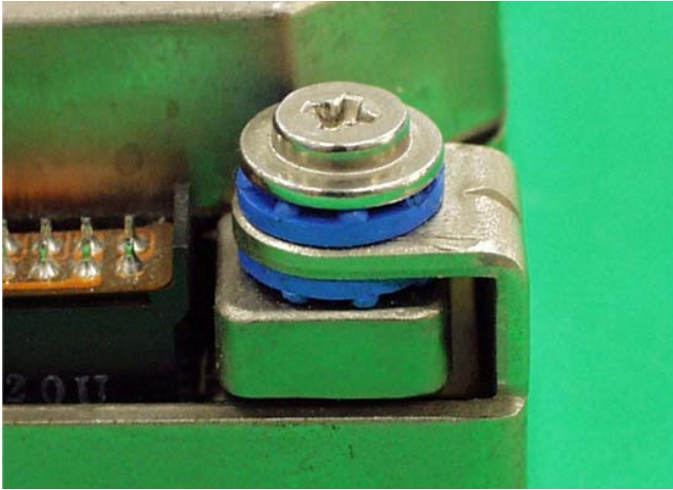

产品名称：抗震线环

规格型号：LTGM11

◆ MATERIAL: TPE

◆ COLOR: BLACK, BLUE, PURPLE, YELLOW

◆ UNIT: mm

用途：用于硬盘及精密零件之防震。

H: 为 55 度硬度 G: 为 45 度硬度.

LTGM11 结构图

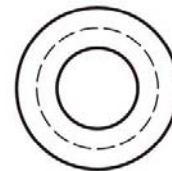
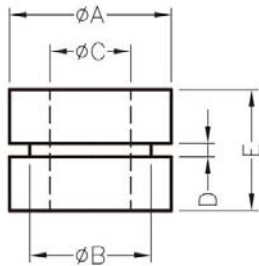

PART NO	A	B	C	D	E	PACKAGE
LTGM11	12.0	9.0	6.0	1.0	9.0	1000

南京诺金电气有限公司

Nanjing Nowking Electric Co., Ltd

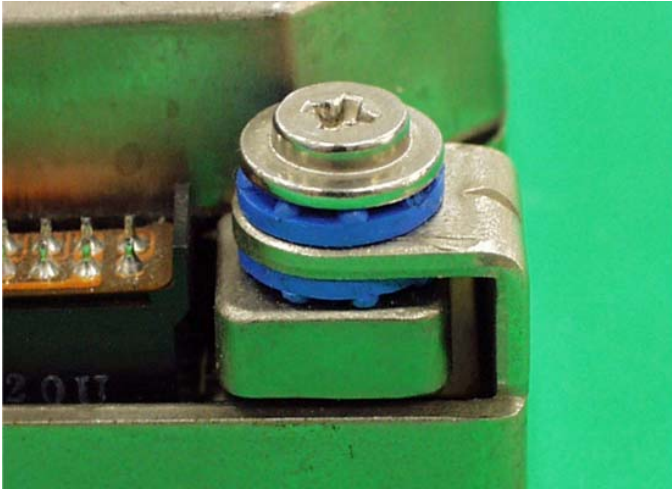

产品名称：抗震线环

规格型号：LTGM12

◆ MATERIAL: TPE

◆ COLOR: BLACK, BLUE, PURPLE, YELLOW

◆ UNIT: mm

用途：用于硬盘及精密零件之防震。

H: 为 55 度硬度 G: 为 45 度硬度。

LTGM12 结构图

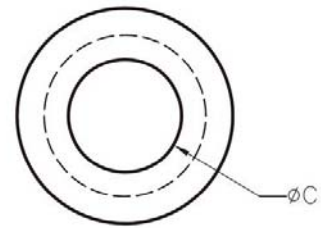
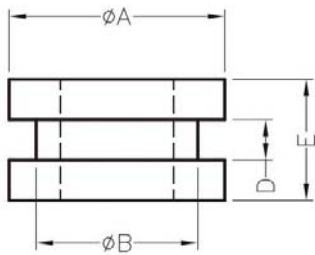

PART NO	A	B	C	D	E	PACKAGE
LTGM12	Ø8.0	Ø6.0	Ø4.2	1.5	4.6	1000

南京诺金电气有限公司

Nanjing Nowking Electric Co., Ltd

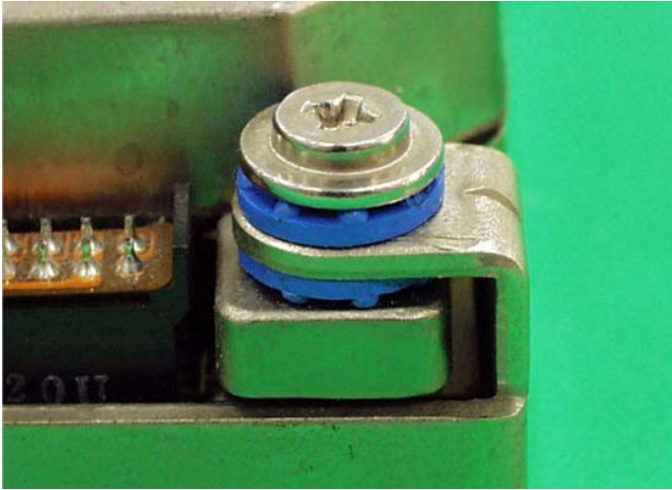

产品名称：抗震线环

规格型号：LTGM13

◆ MATERIAL: TPE

◆ COLOR: BLACK, BLUE, PURPLE, YELLOW

◆ UNIT: mm

用途：用于硬盘及精密零件之防震。

H: 为 55 度硬度 G: 为 45 度硬度.

LTGM13 结构图

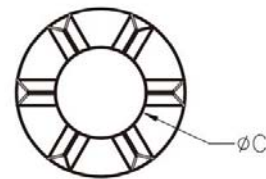
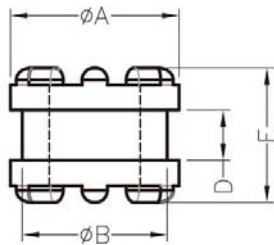

PART NO	A	B	C	D	E	PACKAGE
LTGM13	5.0	4.3	2.7	1.5	4.0	2000

南京诺金电气有限公司

Nanjing Nowking Electric Co., Ltd

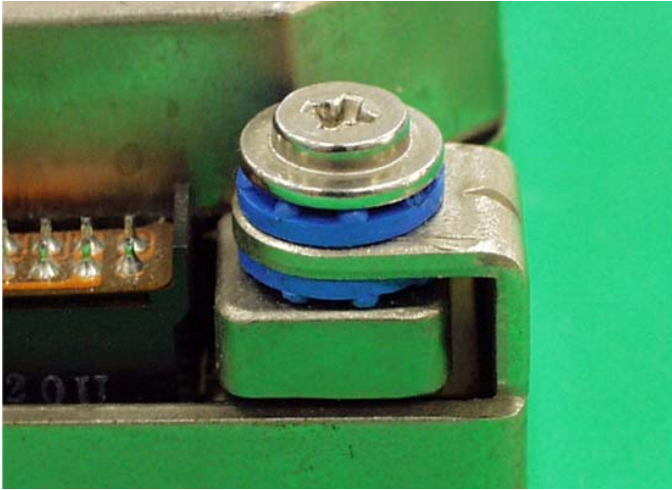

产品名称：抗震线环

规格型号：LTGM14

◆ MATERIAL:TPE

◆ COLOR:BLACK,

◆ UNIT: mm

用途：用于硬盘及精密零件之防震。

H:为 55 度硬度 G:为 45 度硬度.

LTGM14 结构图

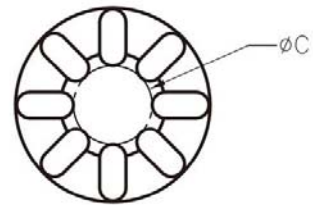
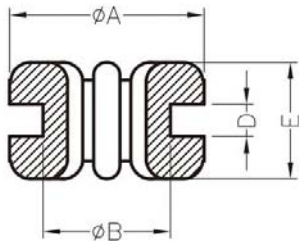

PART NO	A	B	C	D	E	PACKAGE
LTGM14	Ø10.5	Ø7.8	Ø4.75	1.5	6.75	1000

南京诺金电气有限公司

Nanjing Nowking Electric Co., Ltd

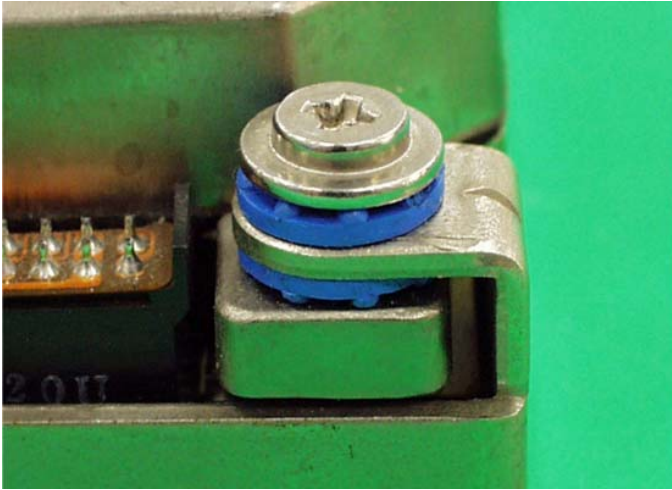

产品名称：抗震线环

规格型号：LTGM15

◆ MATERIAL:TPE

◆ COLOR:BLACK,

◆ UNIT: mm

用途：用于硬盘及精密零件之防震。

H:为 55 度硬度 G:为 45 度硬度.

LTGM15 结构图

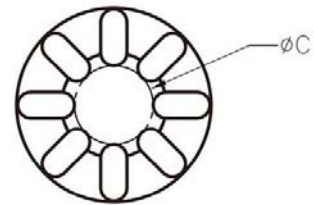
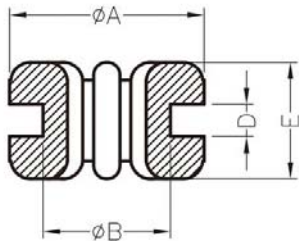

PART NO	A	B	C	D	E	PACKAGE
LTGM15	Ø11.0	Ø7.8	Ø4.75	1.0	8.0	1000

南京诺金电气有限公司

Nanjing Nowking Electric Co., Ltd

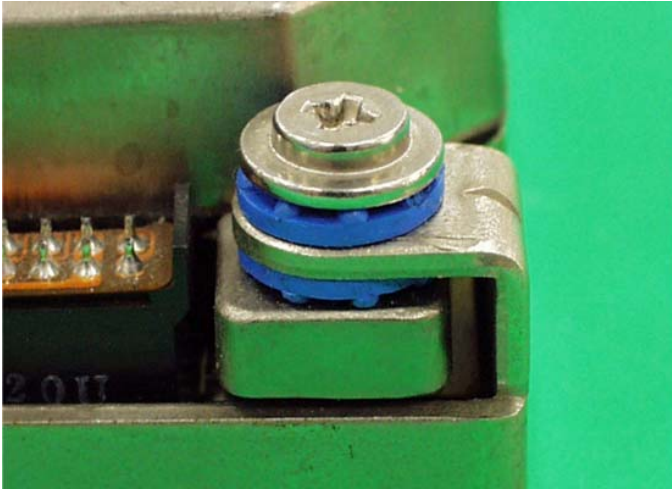

产品名称：抗震线环

规格型号：LTGM16

◆ MATERIAL:TPE

◆ COLOR:BLACK,

◆ UNIT: mm

用途：用于硬盘及精密零件之防震。

H:为 55 度硬度 G:为 45 度硬度.

LTGM16 结构图

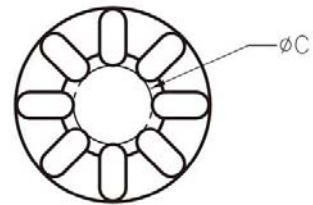
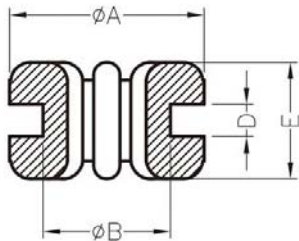

PART NO	A	B	C	D	E	PACKAGE
LTGM16	Ø9.62	Ø6.3	Ø3.9	1.6	5.8	1000

南京诺金电气有限公司

Nanjing Nowking Electric Co., Ltd

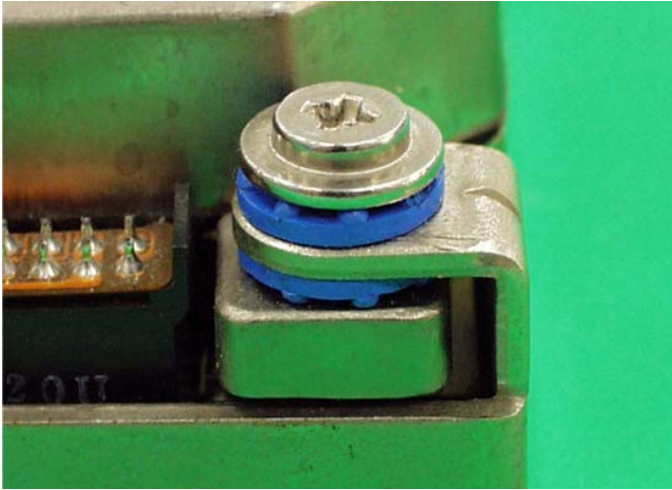

产品名称：抗震线环

规格型号：LTGM17

◆ MATERIAL:TPE

◆ COLOR:BLACK,

◆ UNIT: mm

用途：用于硬盘及精密零件之防震。

H:为 55 度硬度 G:为 45 度硬度.

LTGM17 结构图

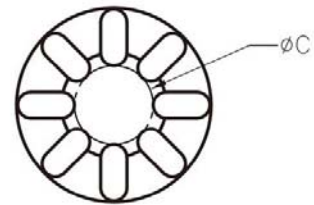
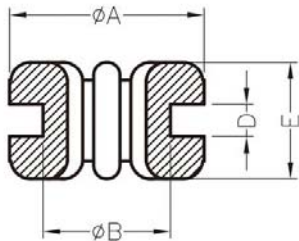

PART NO	A	B	C	D	E	PACKAGE
LTGM17	Ø9.62	Ø6.3	Ø3.9	3.0	7.0	1000

南京诺金电气有限公司

Nanjing Nowking Electric Co., Ltd

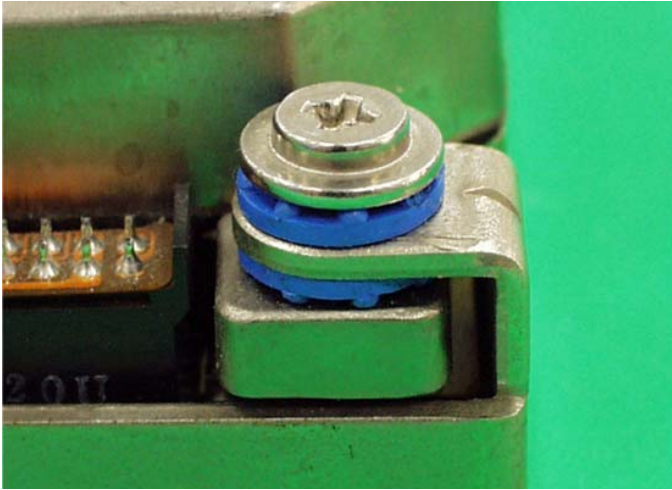

产品名称：抗震线环

规格型号：LTGM18

◆ MATERIAL:TPE

◆ COLOR:BLACK,

◆ UNIT: mm

用途：用于硬盘及精密零件之防震。

H:为 55 度硬度 G:为 45 度硬度.

LTGM18 结构图

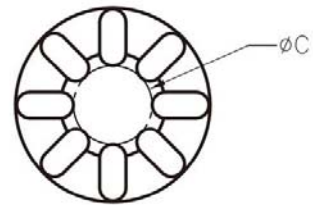
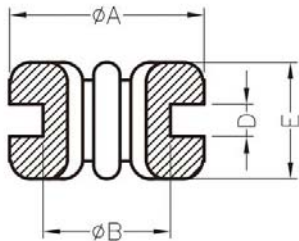

PART NO	A	B	C	D	E	PACKAGE
LTGM18	Ø9.62	Ø6.3	Ø3.9	1.2	5.8	1000

南京诺金电气有限公司

Nanjing Nowking Electric Co., Ltd

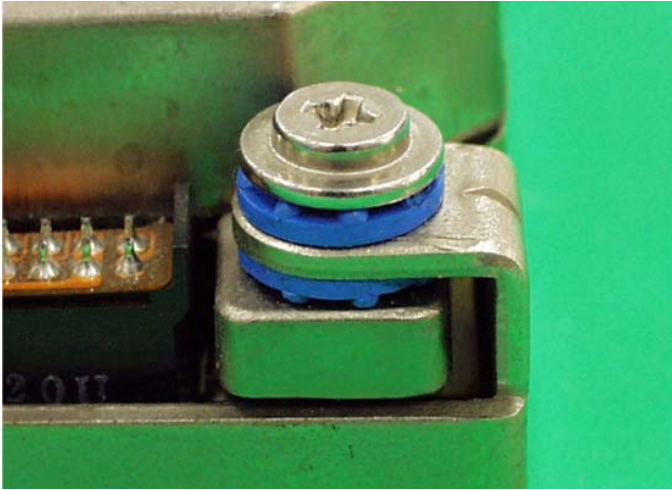

产品名称：抗震线环

规格型号：LTGM19

◆ MATERIAL: TPE

◆ COLOR: BLACK, BLUE, PURPLE, YELLOW

◆ UNIT: mm

用途：用于硬盘及精密零件之防震。

H: 为 55 度硬度 G: 为 45 度硬度.

LTGM19 结构图

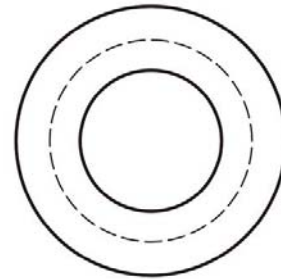
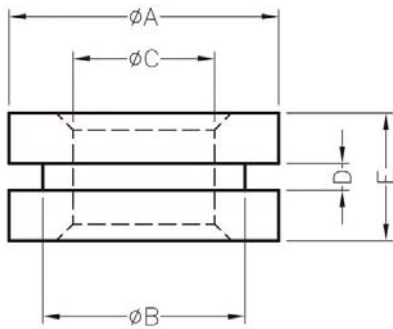

PART NO	A	B	C	D	E	PACKAGE
LTGM19	8.0	6.0	4.2	0.8	3.8	1000

南京诺金电气有限公司

Nanjing Nowking Electric Co., Ltd



产品名称：抗震线环

规格型号：LTGM20

◆ MATERIAL: TPE

◆ COLOR: BLACK, BLUE, PURPLE, YELLOW

◆ UNIT: mm

用途：用于硬盘及精密零件之防震。

H: 为 55 度硬度 G: 为 45 度硬度。

LTGM20 结构图

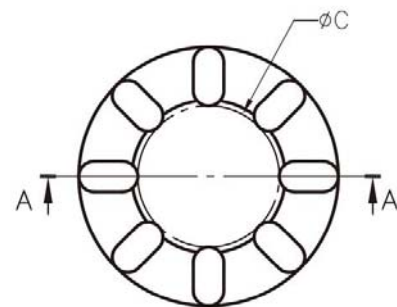
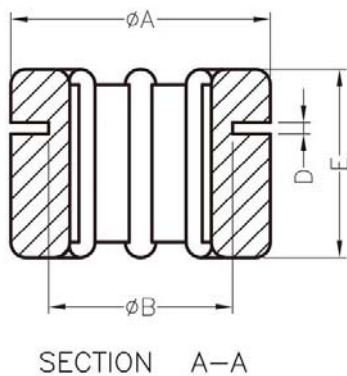

PART NO	A	B	C	D	E	PACKAGE
LTGM20	11.0	7.8	6.0	0.5	8.0	2000

南京诺金电气有限公司

Nanjing Nowking Electric Co., Ltd

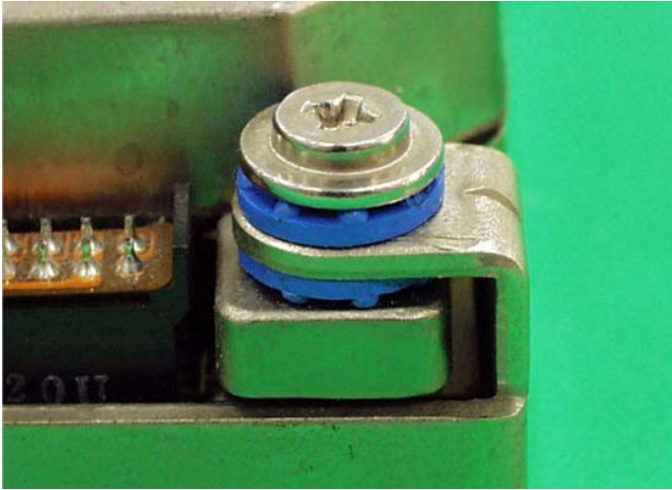

产品名称：抗震线环

规格型号：LTGM21

◆ MATERIAL:TPE

◆ COLOR:BLACK,

◆ UNIT: mm

用途：用于硬盘及精密零件之防震。

H:为 55 度硬度 G:为 45 度硬度.

LTGM21 结构图

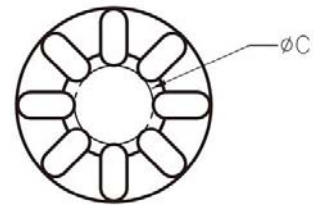
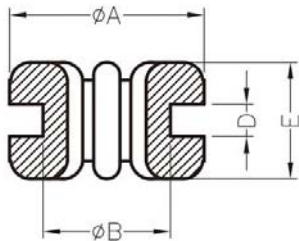

PART NO	A	B	C	D	E	PACKAGE
LTGM21	Ø12.0	Ø9.0	Ø6.0	1.0	9.0	2000

南京诺金电气有限公司

Nanjing Nowking Electric Co., Ltd

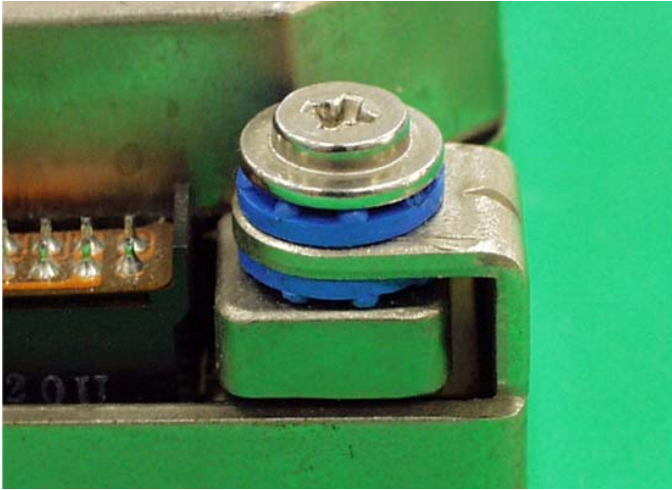

产品名称：抗震线环

规格型号：LTGM22

◆ MATERIAL: TPE

◆ COLOR: BLACK, BLUE, PURPLE, YELLOW

◆ UNIT: mm

用途：用于硬盘及精密零件之防震。

H: 为 55 度硬度 G: 为 45 度硬度.

LTGM22 结构图

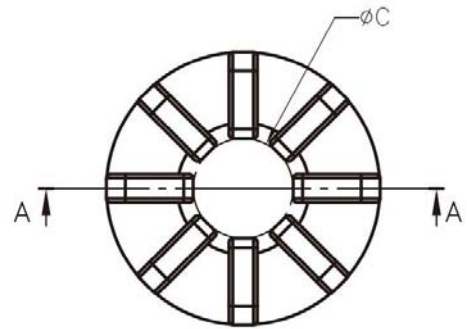
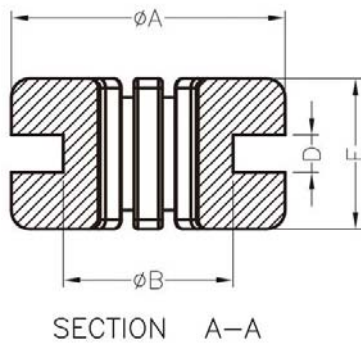

PART NO	A	B	C	D	E	PACKAGE
LTGM22	14.5	9.0	5.3	2.0	8.0	1000

南京诺金电气有限公司

Nanjing Nowking Electric Co., Ltd

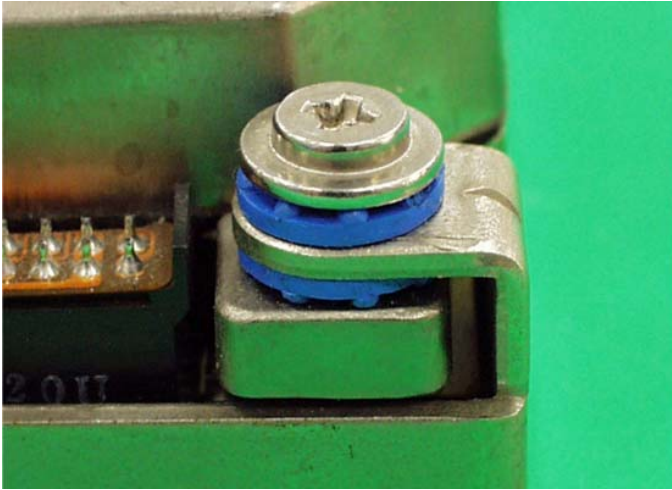

产品名称：抗震线环

规格型号：LTGM23

◆ MATERIAL: TPE

◆ COLOR: BLACK, BLUE, PURPLE, YELLOW

◆ UNIT: mm

用途：用于硬盘及精密零件之防震。

H: 为 55 度硬度 G: 为 45 度硬度.

LTGM23 结构图

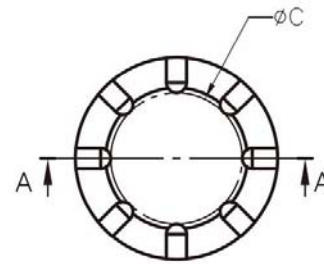
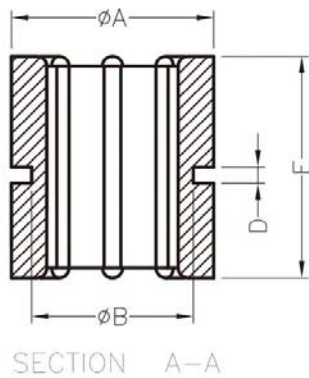

PART NO	A	B	C	D	E	PACKAGE
LTGM23	10.0	8.0	6.5	0.8	11.0	1000

南京诺金电气有限公司

Nanjing Nowking Electric Co., Ltd

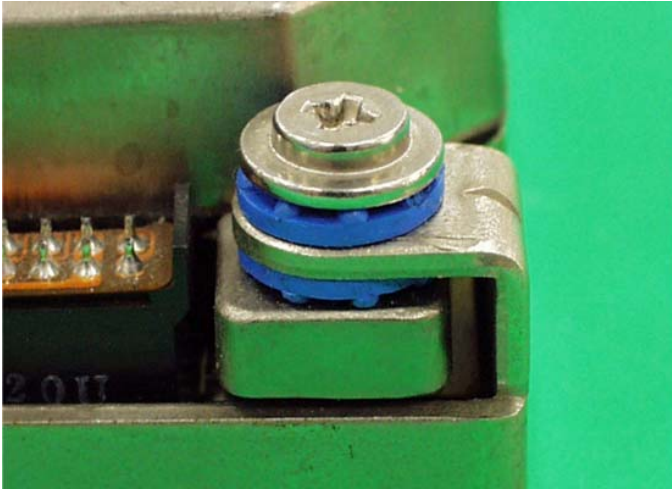

产品名称：抗震线环

规格型号：LTGM24

◆ MATERIAL: TPE

◆ COLOR: BLACK, BLUE, PURPLE, YELLOW

◆ UNIT: mm

用途：用于硬盘及精密零件之防震。

H: 为 55 度硬度 G: 为 45 度硬度。

LTGM24 结构图

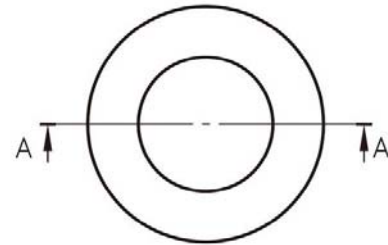
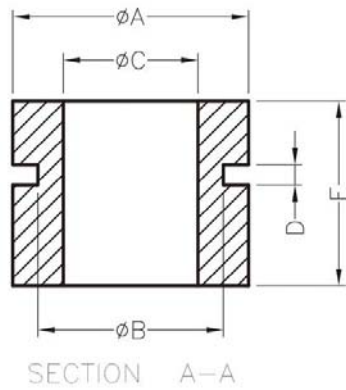

PART NO	A	B	C	D	E	PACKAGE
LTGM24	7.0	5.5	4.0	0.6	5.5	1000

南京诺金电气有限公司

Nanjing Nowking Electric Co., Ltd

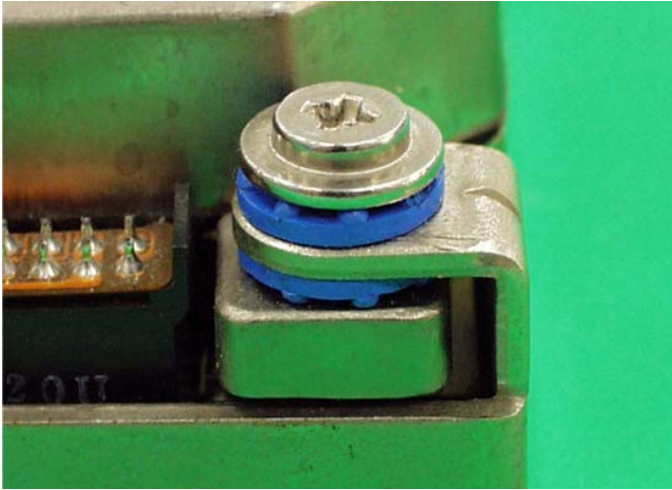

产品名称：抗震线环

规格型号：LTGM25

◆ MATERIAL:TPE

◆ COLOR:BLACK

◆ UNIT: mm

用途：用于硬盘及精密零件之防震。

H:为 55 度硬度 G:为 45 度硬度.

LTGM25 结构图

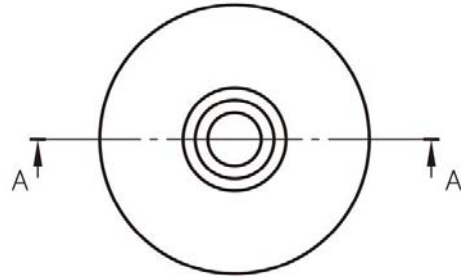
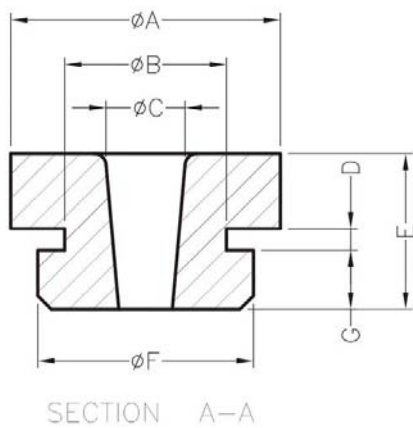

PART NO	A	B	C	D	E	F	G	PACKAGE
LTGM25	10.0	6.0	3.0	0.8	5.8	8.0	2.2	1000

南京诺金电气有限公司

Nanjing Nowking Electric Co., Ltd

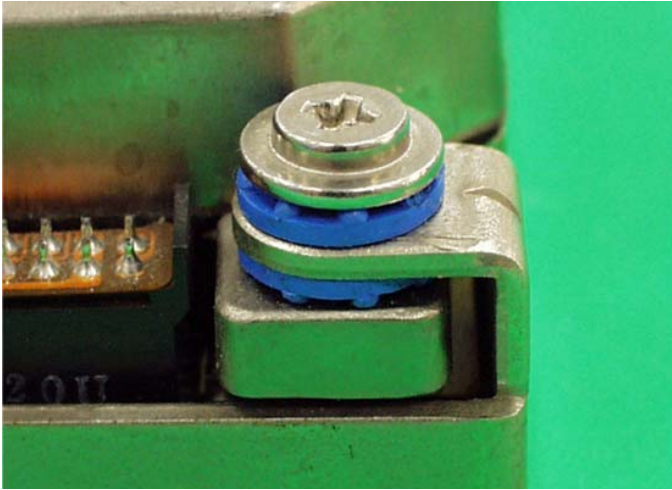

产品名称：抗震线环

规格型号：LTGM26

◆ MATERIAL: TPE

◆ COLOR: BLACK, BLUE, PURPLE, YELLOW

◆ UNIT: mm

用途：用于硬盘及精密零件之防震。

H: 为 55 度硬度 G: 为 45 度硬度.

LTGM26 结构图

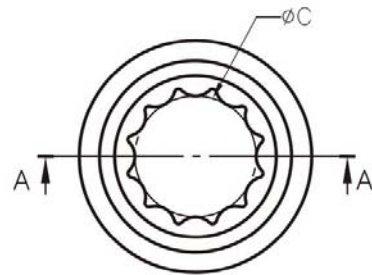
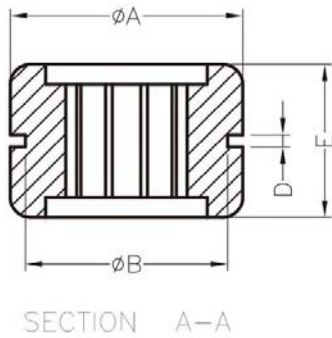

PART NO	A	B	C	D	E	PACKAGE
LTGM26	11.5	8.0	6.0	0.6	7.6	1000

南京诺金电气有限公司

Nanjing Nowking Electric Co., Ltd

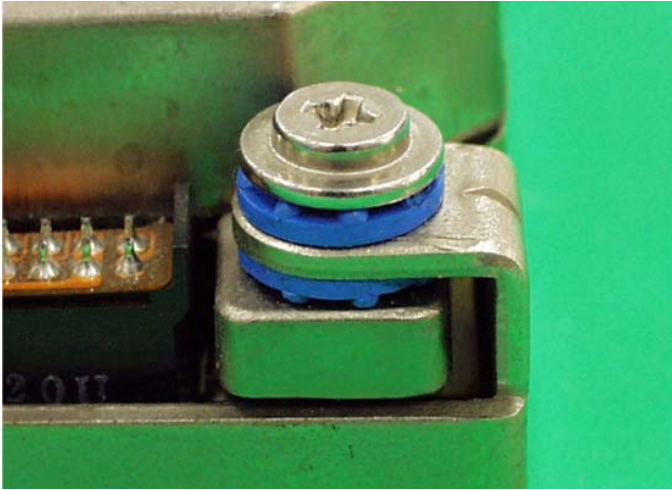

产品名称：抗震线环

规格型号：LTGM27

◆ MATERIAL:TPE

◆ COLOR:BLACK

◆ UNIT: mm

用途：用于硬盘及精密零件之防震。

H:为 55 度硬度 G:为 45 度硬度.

LTGM27 结构图

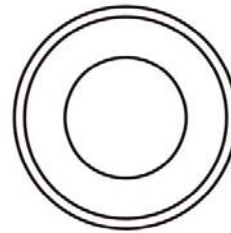
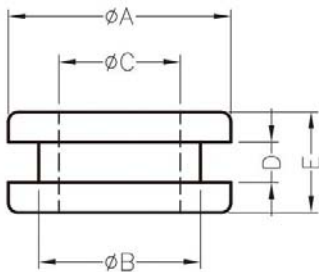

PART NO	A	B	C	D	E	PACKAGE
LTGM27	Ø11.0	Ø8.0	Ø6.0	2.0	5.0	1000

南京诺金电气有限公司

Nanjing Nowking Electric Co., Ltd

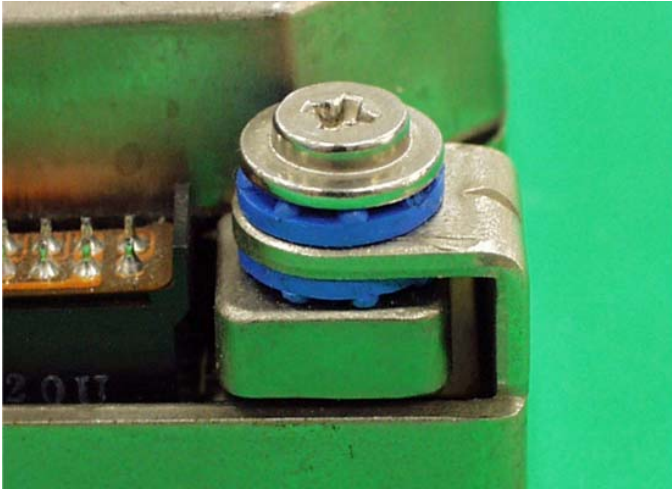

产品名称：抗震线环

规格型号：LTGM28

◆ MATERIAL:TPE

◆ COLOR:BLACK

◆ UNIT: mm

用途：用于硬盘及精密零件之防震。

H:为 55 度硬度 G:为 45 度硬度.

LTGM28 结构图

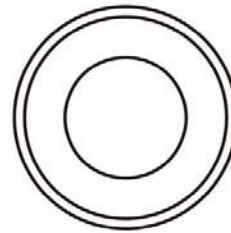
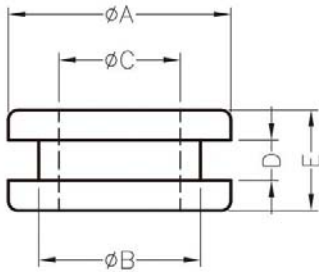

PART NO	A	B	C	D	E	PACKAGE
LTGM28	Ø12.7	Ø9.5	Ø4.8	1.6	5.4	1000

南京诺金电气有限公司

Nanjing Nowking Electric Co., Ltd

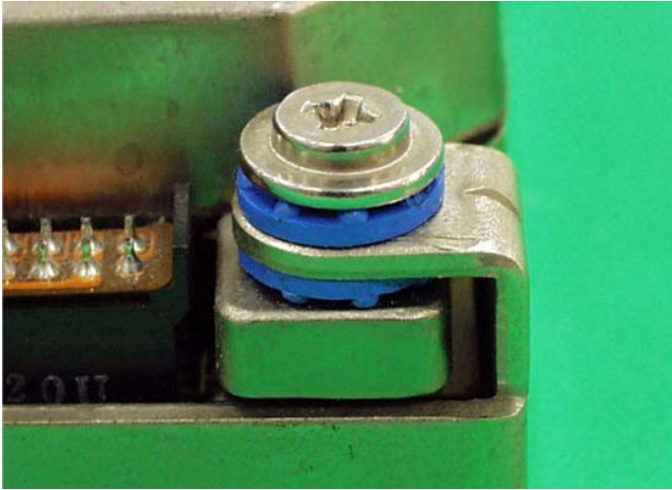

产品名称：抗震线环

规格型号：LTGM29

◆ MATERIAL:TPE

◆ COLOR:BLACK

◆ UNIT: mm

用途：用于硬盘及精密零件之防震。

H:为 55 度硬度 G:为 45 度硬度.

LTGM29 结构图

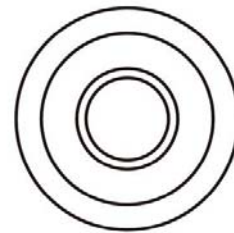
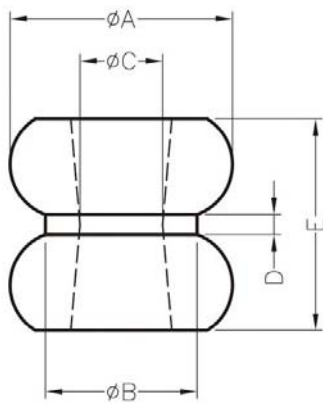

PART NO	A	B	C	D	E	PACKAGE
LTGM29	11.0	7.5	4.08	1.0	10.5	1000

南京诺金电气有限公司

Nanjing Nowking Electric Co., Ltd

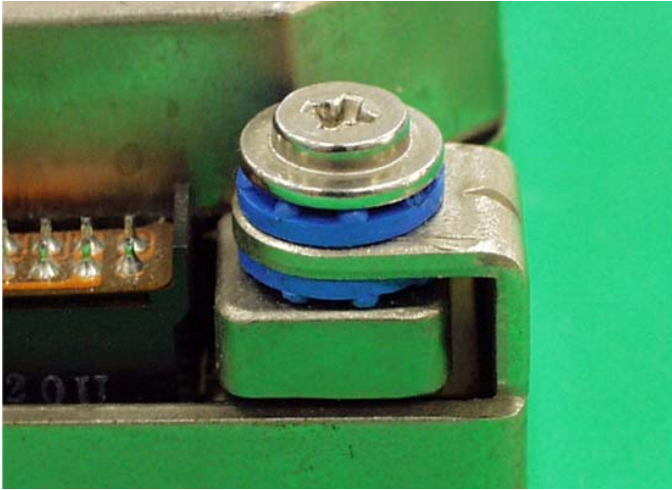

产品名称：抗震线环

规格型号：LTGM30

◆ MATERIAL:TPE

◆ COLOR:BLACK

◆ UNIT: mm

用途：用于硬盘及精密零件之防震。

H:为 55 度硬度 G:为 45 度硬度.

LTGM30 结构图

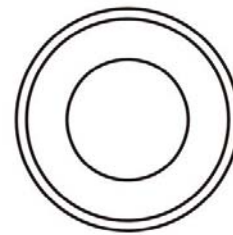
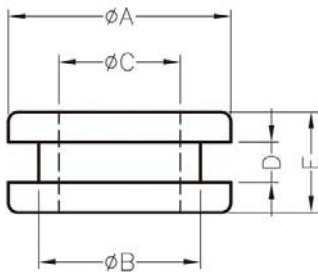

PART NO	A	B	C	D	E	PACKAGE
LTGM30	Ø7.0	Ø5.5	Ø3.9	0.9	2.8	1000

南京诺金电气有限公司

Nanjing Nowking Electric Co., Ltd

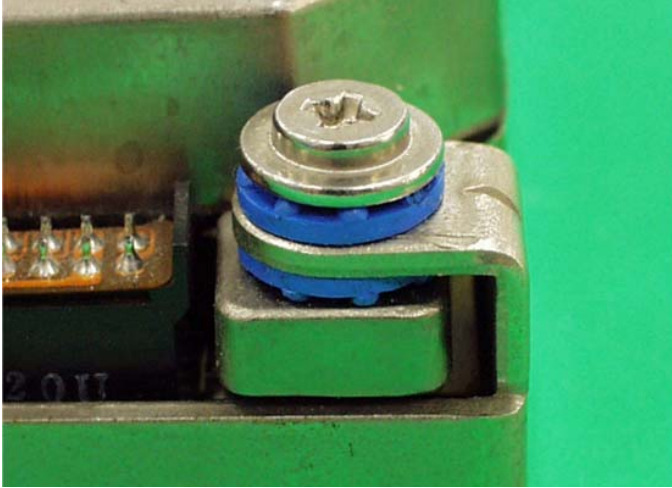

产品名称：抗震线环

规格型号：LTGM31

◆ MATERIAL:TPE

◆ COLOR:BLACK

◆ UNIT: mm

用途：用于硬盘及精密零件之防震。

H:为 55 度硬度 G:为 45 度硬度.

LTGM31 结构图

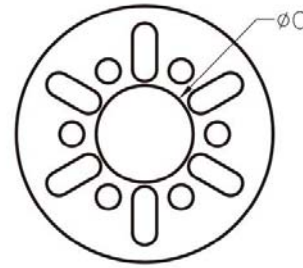
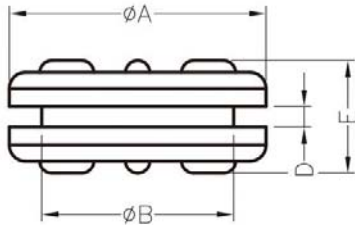

PART NO	A	B	C	D	E	PACKAGE
LTGM31	12.7	9.5	4.8	1.0	5.6	1000

南京诺金电气有限公司

Nanjing Nowking Electric Co., Ltd

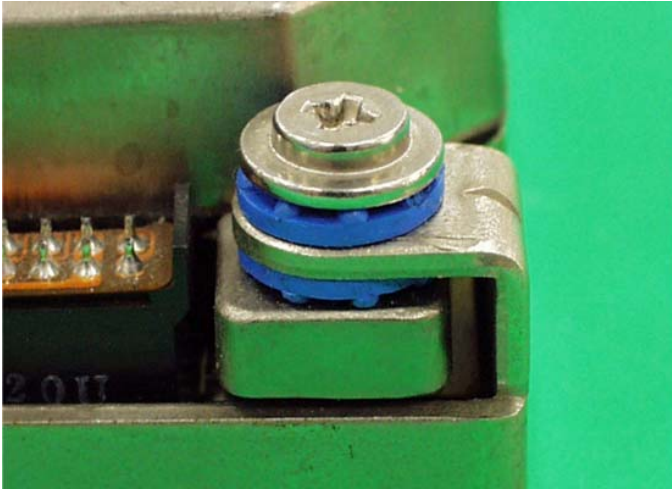

产品名称：抗震线环

规格型号：LTGM32

◆ MATERIAL:TPE

◆ COLOR:BLACK

◆ UNIT: mm

用途：用于硬盘及精密零件之防震。

H:为 55 度硬度 G:为 45 度硬度.

LTGM32 结构图

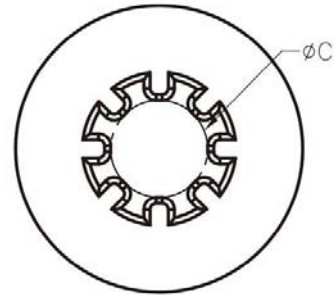
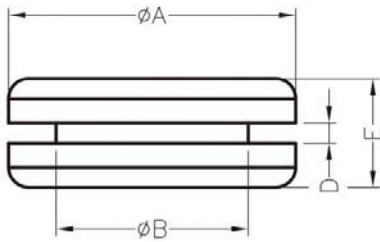

PART NO	A	B	C	D	E	PACKAGE
LTGM32	14.2	9.5	4.8	1.0	5.4	1000

南京诺金电气有限公司

Nanjing Nowking Electric Co., Ltd

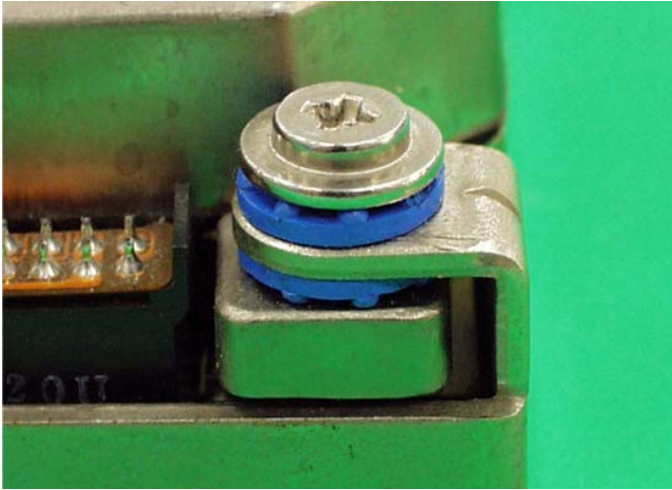

产品名称：抗震线环

规格型号：LTGM33

◆ MATERIAL:TPE

◆ COLOR:BLACK

◆ UNIT: mm

用途：用于硬盘及精密零件之防震。

H:为 55 度硬度 G:为 45 度硬度.

LTGM33 结构图

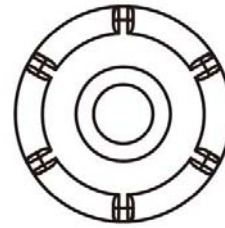
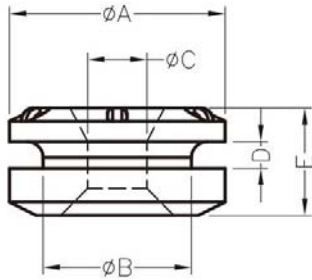

PART NO	A	B	C	D	E	PACKAGE
LTGM33	8.0	5.5	2.2	1.0	4.0	1000

南京诺金电气有限公司

Nanjing Nowking Electric Co., Ltd

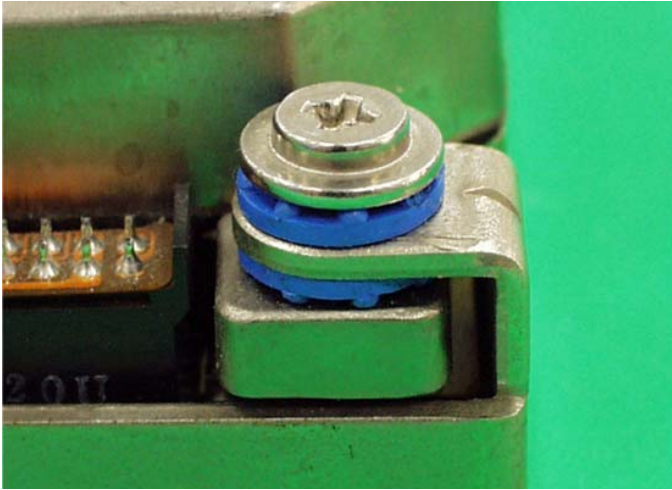

产品名称：抗震线环

规格型号：LTGM34

◆ MATERIAL:TPE

◆ COLOR:BLACK

◆ UNIT: mm

用途：用于硬盘及精密零件之防震。

H:为 55 度硬度 G:为 45 度硬度.

LTGM34 结构图

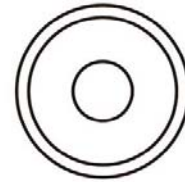
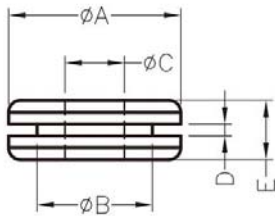

PART NO	A	B	C	D	E	PACKAGE
LTGM34	Ø14.2	Ø9.5	Ø4.9	1.0	4.9	1000

南京诺金电气有限公司

Nanjing Nowking Electric Co., Ltd

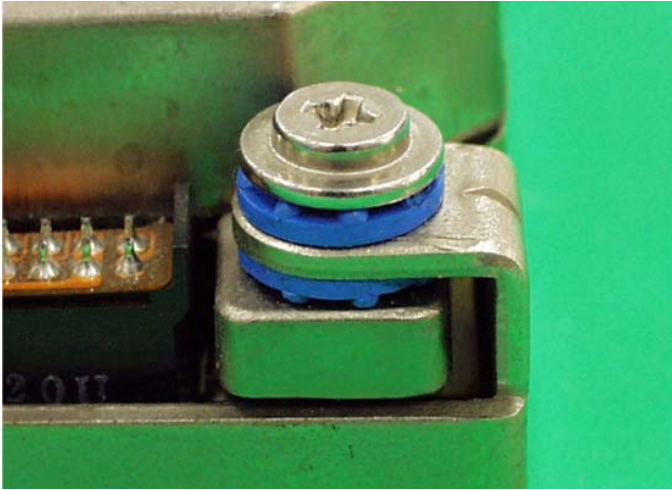

产品名称：抗震线环

规格型号：LTGM35

◆ MATERIAL:TPE

◆ COLOR:BLACK

◆ UNIT: mm

用途：用于硬盘及精密零件之防震。

H:为 55 度硬度 G:为 45 度硬度.

LTGM35 结构图

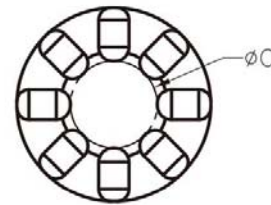
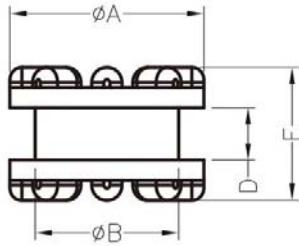

PART NO	A	B	C	D	E	PACKAGE
LTGM35	9.6	7.1	4.3	2.6	6.6	1000

南京诺金电气有限公司

Nanjing Nowking Electric Co., Ltd



产品名称：抗震线环

规格型号：LTGM36

- ◆ MATERIAL:TPE
- ◆ COLOR:BLACK,BLUE
- ◆ MATERIAL:ZINC PALTED STEEL
- ◆ UNIT: mm

用途：用于硬盘及精密零件之防震。

H:为 55 度硬度 G:为 45 度硬度.

MATERIAL 2 为插稍材质

LTGM36 结构图

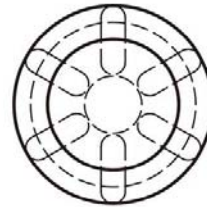
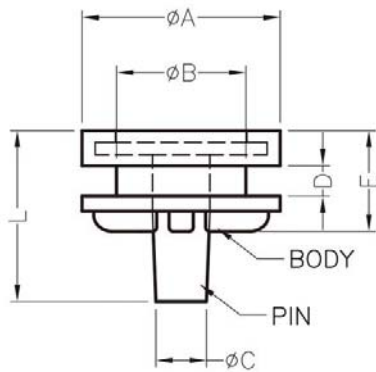

PART NO	A	B	C	D	E	L	PACKAGE
LTGM36	Ø9.8	Ø6.4	Ø2.5	1.5	5	8.5	1000

南京诺金电气有限公司

Nanjing Nowking Electric Co., Ltd



产品名称：抗震线环

规格型号：LTGM37

◆ MATERIAL:TPE

◆ COLOR:BLUE

◆ MATERIAL 2: STEEL

◆ UNIT: mm

用途：用于硬盘及精密零件之防震。

MATERIAL 2 为螺丝材质

LTGM37 结构图

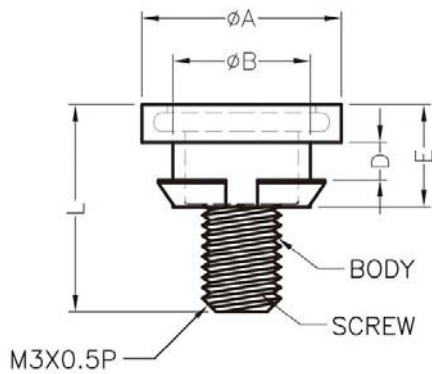

PART NO	A	B	C	D	E	L	PACKAGE
LTGM37	$\phi 7.4$	$\phi 5.1$	1.4	3.8	$\phi 4.2$	7.7	1000

南京诺金电气有限公司

Nanjing Nowking Electric Co., Ltd

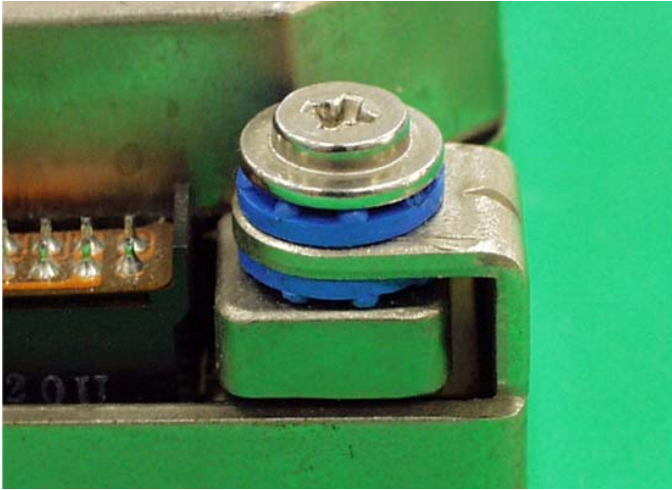

产品名称：抗震线环

规格型号：LTGM3

◆ MATERIAL:TPE

◆ COLOR:BLACK

◆ UNIT: mm

用途：用于硬盘及精密零件之防震。

H:为 55 度硬度 G:为 45 度硬度.

LTGM38 结构图

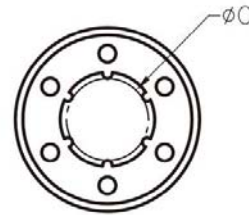
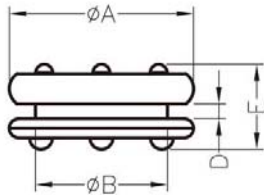

PART NO	A	B	C	D	E	PACKAGE
LTGM38	9.76	7.0	4.35	0.8	4.53	1000

南京诺金电气有限公司

Nanjing Nowking Electric Co., Ltd



产品名称：抗震线环

规格型号：LTGM39

◆ MATERIAL:TPE

◆ COLOR:BLUE,BLACK

◆ MATERIAL 2: ZINC PLATED STEEL

◆ UNIT: mm

用途：用于硬盘及精密零件之防震。

MATERIAL 2 为插梢材质

LTGM39 结构图

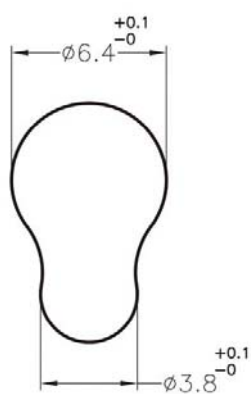
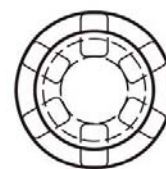
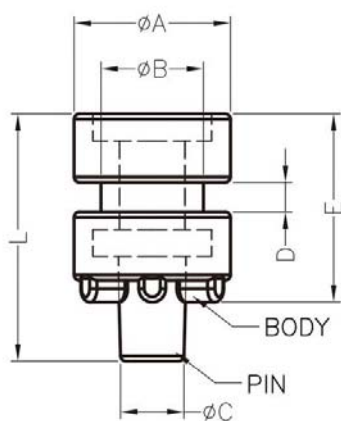

MOUNTING HOLE

PART NO	A	B	C	D	E	L	PACKAGE
LTGM39	Ø5.8	Ø3.8	Ø2.35	1.1	7.0	9.2	1000

总机/TEL:+86 25 85437901 85422485 85436028
[Http://www.nowking.com](http://www.nowking.com) E-mail: nk@nowking.com
 QQ: 260678075 WeChat:13770725488

南京诺金电气有限公司

Nanjing Nowking Electric Co., Ltd



产品名称：抗震线环

规格型号：LTGM40

◆ MATERIAL:TPE

◆ COLOR:BLUE,BLACK

◆ MATERIAL 2: ZINC PLATED STEEL

◆ UNIT: mm

用途：用于硬盘及精密零件之防震。

MATERIAL 2 为插梢材质

LTGM40 结构图

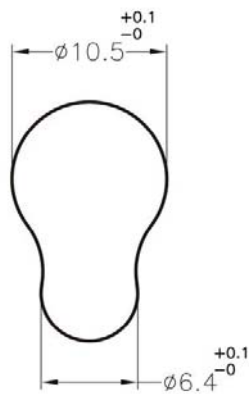
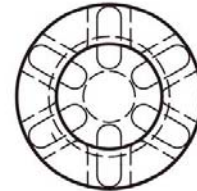
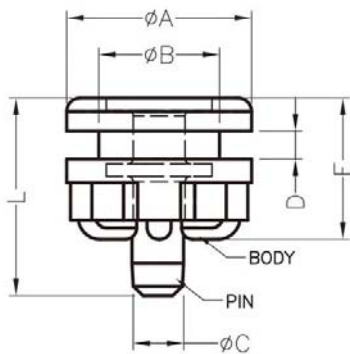

MOUNTING HOLE

PART NO	A	B	C	D	E	L	PACKAGE
LTGM40	9.8	6.4	2.6	1.5	7.5	10.5	1000

总机/TEL:+86 25 85437901 85422485 85436028
[Http://www.nowking.com](http://www.nowking.com) E-mail: nk@nowking.com
 QQ: 260678075 WeChat:13770725488

南京诺金电气有限公司

Nanjing Nowking Electric Co., Ltd



产品名称：抗震线环

规格型号：LTGM41

◆ MATERIAL:TPE

◆ COLOR:BLUE,BLACK

◆ UNIT: mm

用途：用于硬盘及精密零件之防震。

LTGM41 结构图

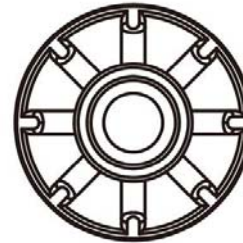
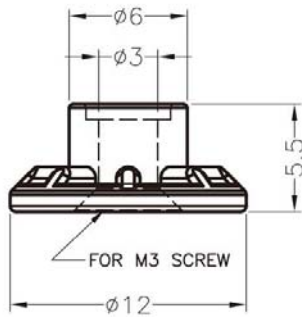

MOUNTING HOLE $\phi 6$

PART NO	PACKAGE
LTGM41	1000

南京诺金电气有限公司

Nanjing Nowking Electric Co., Ltd



产品名称：抗震线环

规格型号：LTGM42

◆MATERIAL:RUBBER,SILICON
RUBBER

◆COLOR:BLUE,BLACK

◆UNIT: mm

用途：用于硬盘及精密零件之防震。

LTGM42 结构图

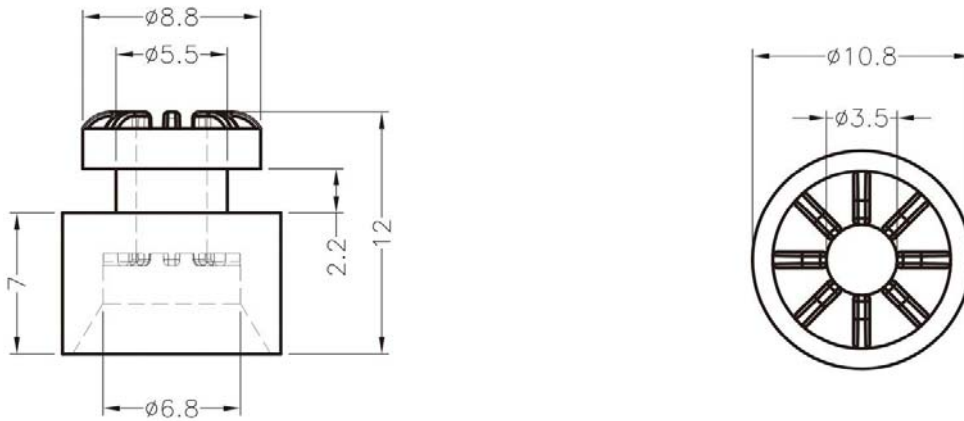

PART NO	PACKAGE
LTGM42	1000

南京诺金电气有限公司

Nanjing Nowking Electric Co., Ltd



产品名称：抗震线环

规格型号：LTGM43

◆MATERIAL: RUBBER, SILICON
RUBBER

◆COLOR: BLACK

◆UNIT: mm

用途：用于硬盘及精密零件之防震。

LTGM43 结构图

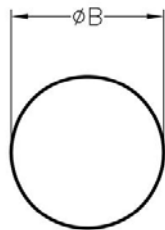
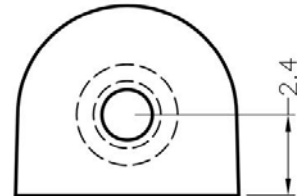
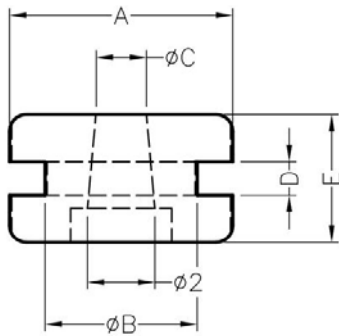

MOUNTING HOLES

PART NO	A	B	C	D	E	PACKAGE
LTGM43	6.63	4.52	1.5	1.0	3.8	1000

总机/TEL: +86 25 85437901 85422485 85436028
[Http://www.nowking.com](http://www.nowking.com) E-mail: nk@nowking.com
 QQ: 260678075 WeChat: 13770725488

南京诺金电气有限公司

Nanjing Nowking Electric Co., Ltd



产品名称: 抗震线环

规格型号: LTGM44

◆ MATERIAL: RUBBER, SILICON
RUBBER

◆ COLOR: BLACK

◆ UNIT: mm

用途: 用于硬盘及精密零件之防震。

LTGM44 结构图

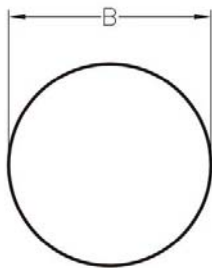
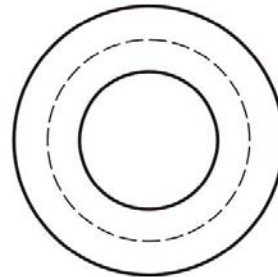
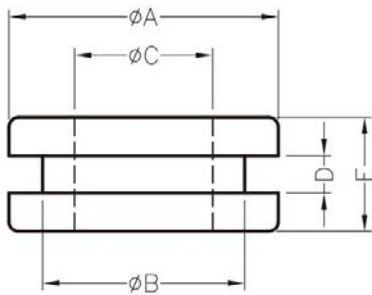

MOUNTING HOLES

PART NO	A	B	C	D	E	PACKAGE
LTGM44	8.0	6.0	4.1	1.1	3.4	1000

总机/TEL: +86 25 85437901 85422485 85436028
[Http://www.nowking.com](http://www.nowking.com) E-mail: nk@nowking.com
 QQ: 260678075 WeChat: 13770725488

南京诺金电气有限公司

Nanjing Nowking Electric Co., Ltd



产品名称：抗震线环

规格型号：LTGM45

◆MATERIAL: RUBBER, SILICON
RUBBER

◆COLOR: BLACK

◆UNIT: mm

用途：用于硬盘及精密零件之防震。

LTGM45 结构图

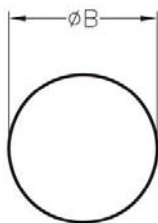
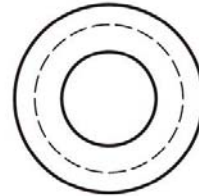
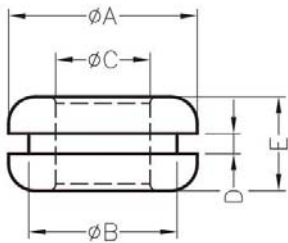

MOUNTING HOLES

PART NO	A	B	C	D	E	PACKAGE
LTGM45	14.0	11.0	7.0	1.5	7.0	1000

总机/TEL: +86 25 85437901 85422485 85436028
[Http://www.nowking.com](http://www.nowking.com) E-mail: nk@nowking.com
 QQ: 260678075 WeChat: 13770725488

南京诺金电气有限公司

Nanjing Nowking Electric Co., Ltd



产品名称：抗震线环

规格型号：LTGM46

◆MATERIAL: RUBBER, SILICON
RUBBER

◆COLOR: BLACK

◆UNIT: mm

用途：用于硬盘及精密零件之防震。

LTGM46 结构图

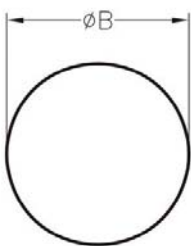
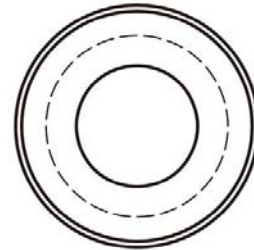
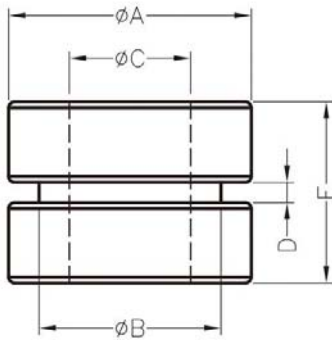

MOUNTING HOLES

PART NO	A	B	C	D	E	PACKAGE
LTGM46	12.0	9.0	6.0	1.0	9.0	1000

总机/TEL: +86 25 85437901 85422485 85436028
[Http://www.nowking.com](http://www.nowking.com) E-mail: nk@nowking.com
 QQ: 260678075 WeChat: 13770725488

南京诺金电气有限公司

Nanjing Nowking Electric Co., Ltd



产品名称：抗震线环

规格型号：LTGM47

◆ MATERIAL: RUBBER, SILICON
RUBBER

◆ COLOR: BLACK

◆ UNIT: mm

用途：用于硬盘及精密零件之防震。

LTGM47 结构图

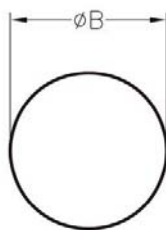
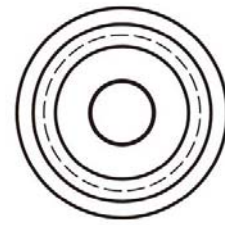
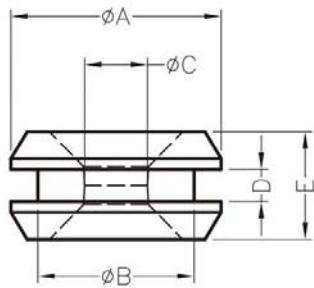

MOUNTING HOLES

PART NO	A	B	C	D	E	PACKAGE
LTGM47	7.8	5.8	2.33	1.2	4.0	1000

总机/TEL: +86 25 85437901 85422485 85436028
[Http://www.nowking.com](http://www.nowking.com) E-mail: nk@nowking.com
 QQ: 260678075 WeChat: 13770725488

南京诺金电气有限公司

Nanjing Nowking Electric Co., Ltd



产品名称：抗震线环

规格型号：LTGM48

◆MATERIAL: RUBBER, SILICON
RUBBER

◆COLOR: BLACK

◆UNIT: mm

用途：用于硬盘及精密零件之防震。

LTGM48 结构图

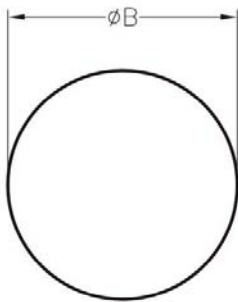
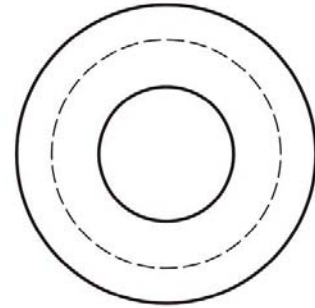
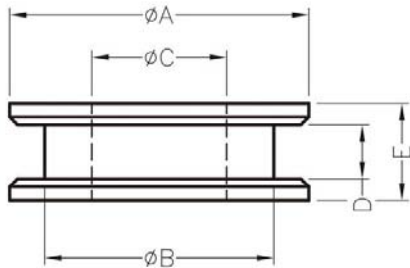

MOUNTING HOLES

PART NO	A	B	C	D	E	PACKAGE
LTGM48	11.1	8.5	5.0	2.0	3.6	1000

总机/TEL: +86 25 85437901 85422485 85436028
[Http://www.nowking.com](http://www.nowking.com) E-mail: nk@nowking.com
 QQ: 260678075 WeChat: 13770725488

南京诺金电气有限公司

Nanjing Nowking Electric Co., Ltd



产品名称：抗震线环

规格型号：LTGM49

◆MATERIAL: RUBBER, SILICON
RUBBER

◆COLOR: BLACK

◆UNIT: mm

用途：用于硬盘及精密零件之防震。

LTGM49 结构图

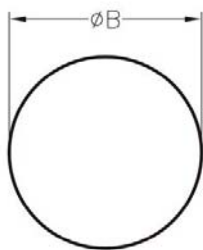
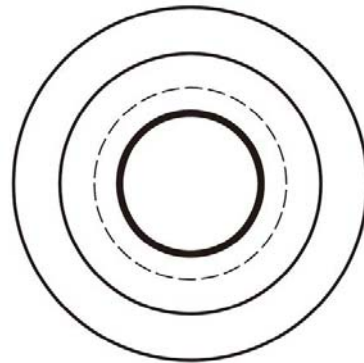
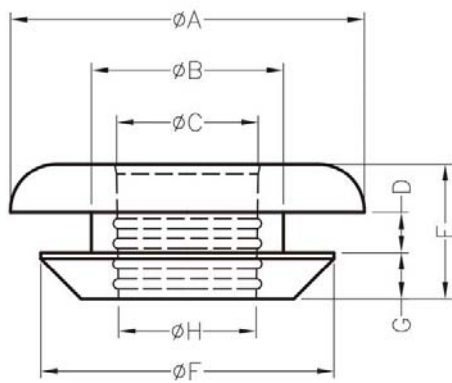

MOUNTING HOLES

PART NO	A	B	C	D	E	F	G	H	PACKAGE
LTGM49	17.5	9.5	7.2	2.0	6.7	14.5	2.3	6.8	1000

总机/TEL: +86 25 85437901 85422485 85436028
[Http://www.nowking.com](http://www.nowking.com) E-mail: nk@nowking.com
 QQ: 260678075 WeChat: 13770725488

南京诺金电气有限公司

Nanjing Nowking Electric Co., Ltd



产品名称: 抗震线环

规格型号: LTGM50

◆ MATERIAL: RUBBRE, SILICON
RUBBER

◆ COLOR: BLACK

◆ UNIT: mm

用途: 用于硬盘及精密零件之防震。

LTGM50 结构图

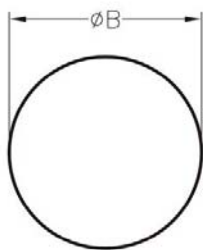
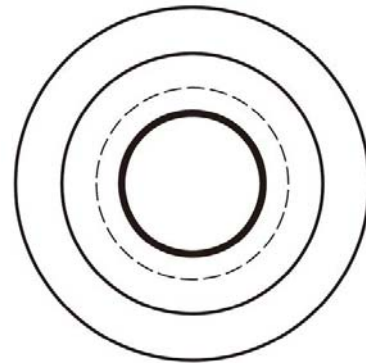
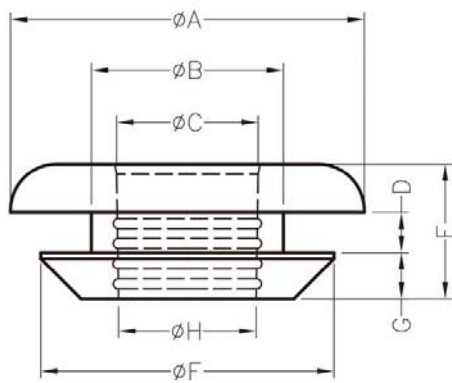

MOUNTING HOLES

PART NO	A	B	C	D	E	F	G	H	PACKAGE
LTGM50	17.5	9.5	6.8	2.0	6.7	14.5	2.3	6.3	1000

总机/TEL: +86 25 85437901 85422485 85436028
[Http://www.nowking.com](http://www.nowking.com) E-mail: nk@nowking.com
 QQ: 260678075 WeChat: 13770725488

南京诺金电气有限公司

Nanjing Nowking Electric Co., Ltd



产品名称：抗震线环

规格型号：LTGM51

◆MATERIAL: RUBBER, SILICON
RUBBER

◆COLOR: BLACK

◆UNIT: mm

用途：用于硬盘及精密零件之防震。

LTGM51 结构图

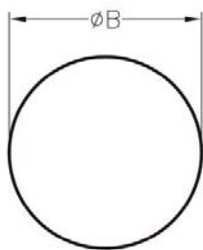
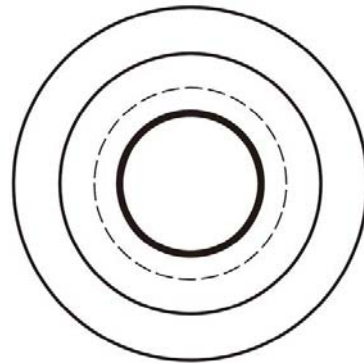
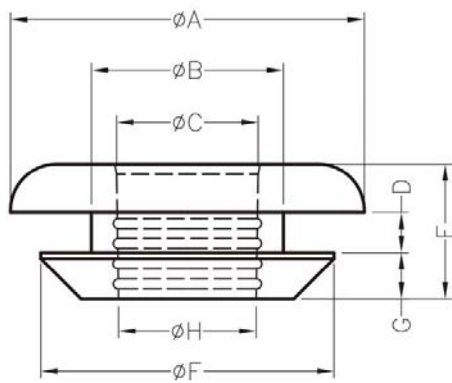

MOUNTING HOLES

PART NO	A	B	C	D	E	F	G	H	PACKAGE
LTGM51	18.5	10.5	8.2	2.0	6.7	15.5	2.3	7.8	1000

总机/TEL: +86 25 85437901 85422485 85436028
[Http://www.nowking.com](http://www.nowking.com) E-mail: nk@nowking.com
 QQ: 260678075 WeChat: 13770725488

南京诺金电气有限公司

Nanjing Nowking Electric Co., Ltd



产品名称：抗震线环

规格型号：LTGM52

◆MATERIAL: RUBBER, SILICON
RUBBER

◆COLOR: BLACK

◆UNIT: mm

用途：用于硬盘及精密零件之防震。

LTGM52 结构图

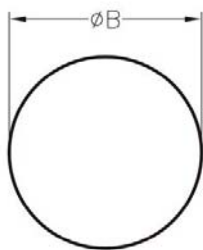
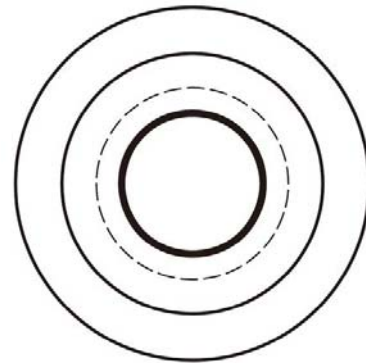
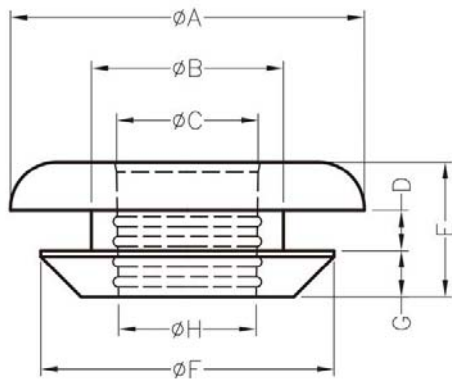

MOUNTING HOLES

PART NO	A	B	C	D	E	F	G	H	PACKAGE
LTGM52	19.5	11.5	9.2	2.0	6.7	16.5	2.3	8.8	1000

总机/TEL: +86 25 85437901 85422485 85436028
[Http://www.nowking.com](http://www.nowking.com) E-mail: nk@nowking.com
 QQ: 260678075 WeChat: 13770725488

南京诺金电气有限公司

Nanjing Nowking Electric Co., Ltd



产品名称：抗震线环

规格型号：LTGM53

◆ MATERIAL: RUBBER, SILICON
RUBBER

◆ COLOR: BLACK

◆ UNIT: mm

用途：用于硬盘及精密零件之防震。

LTGM53 结构图

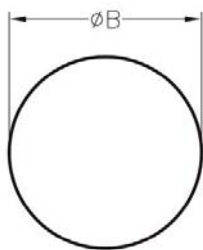
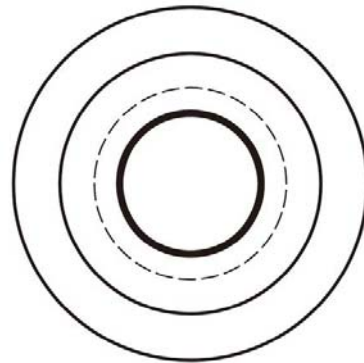
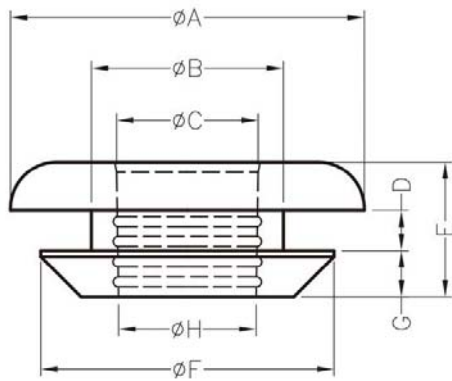

MOUNTING HOLES

PART NO	A	B	C	D	E	F	G	H	PACKAGE
LTGM53	17.5	9.5	6.2	2.0	6.7	14.5	2.3	5.8	1000

总机/TEL: +86 25 85437901 85422485 85436028
[Http://www.nowking.com](http://www.nowking.com) E-mail: nk@nowking.com
 QQ: 260678075 WeChat: 13770725488

南京诺金电气有限公司

Nanjing Nowking Electric Co., Ltd



产品名称：抗震线环

规格型号：LTGM54

◆MATERIAL: RUBBER, SILICON
RUBBER

◆COLOR: BLACK

◆UNIT: mm

用途：用于硬盘及精密零件之防震。

LTGM54 结构图

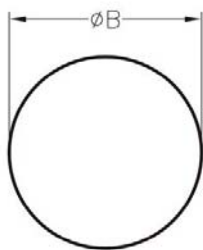
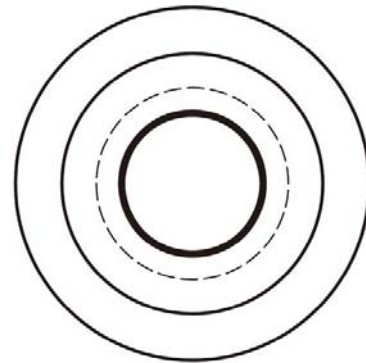
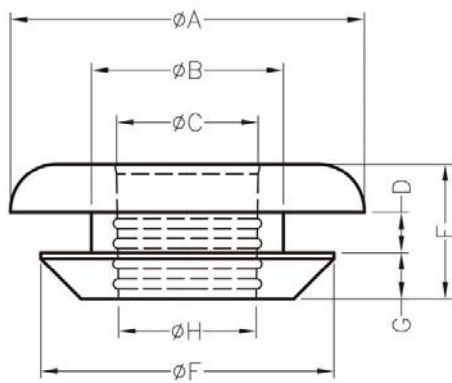

MOUNTING HOLES

PART NO	A	B	C	D	E	F	G	H	PACKAGE
LTGM54	17.5	11.5	7.2	2.0	6.7	16.5	2.3	6.8	1000

总机/TEL: +86 25 85437901 85422485 85436028
[Http://www.nowking.com](http://www.nowking.com) E-mail: nk@nowking.com
 QQ: 260678075 WeChat: 13770725488

南京诺金电气有限公司

Nanjing Nowking Electric Co., Ltd



产品名称：抗震线环

规格型号：LTGM55

◆MATERIAL: RUBBER, SILICON
RUBBER

◆COLOR: BLACK

◆UNIT: mm

用途：用于硬盘及精密零件之防震。

LTGM55 结构图

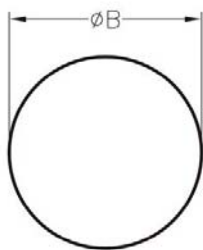
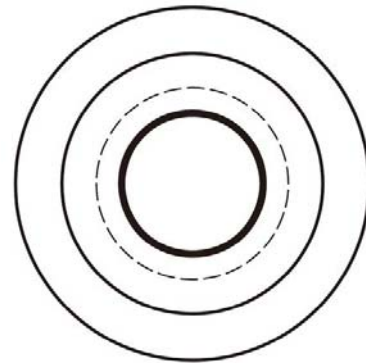
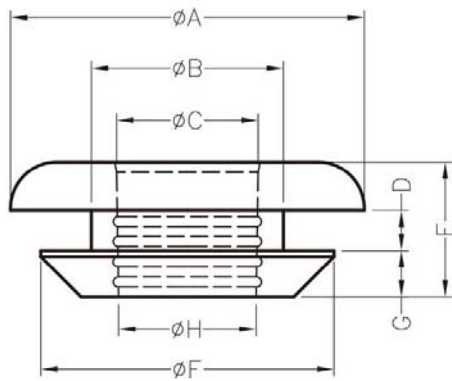

MOUNTING HOLES

PART NO	A	B	C	D	E	F	G	H	PACKAGE
LTGM55	17.5	11.5	7.6	2.0	6.7	16.5	2.3	7.2	1000

总机/TEL: +86 25 85437901 85422485 85436028
[Http://www.nowking.com](http://www.nowking.com) E-mail: nk@nowking.com
 QQ: 260678075 WeChat: 13770725488

南京诺金电气有限公司

Nanjing Nowking Electric Co., Ltd

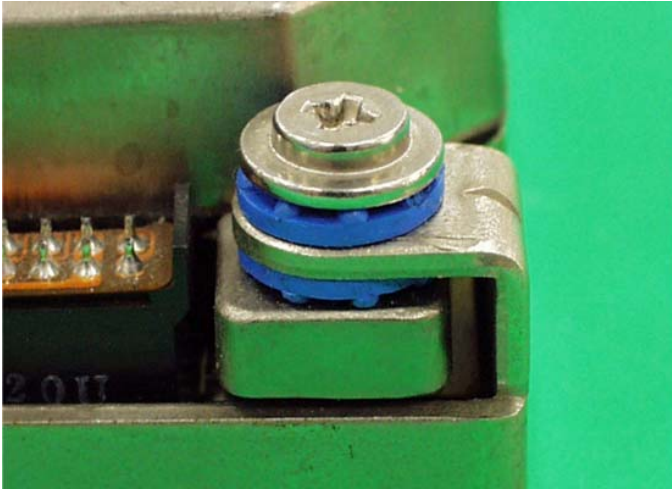

产品名称：抗震线环

规格型号：LTGM56

◆ MATERIAL: TPE

◆ COLOR: BALCK, BLUE, PURPLE, YELLOW

◆ UNIT: mm

用途：用于硬盘及精密零件之防震。

G: 为 45 度硬度 H: 为 55 度硬度

LTGM56 结构图

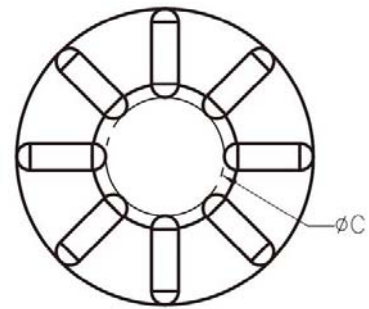
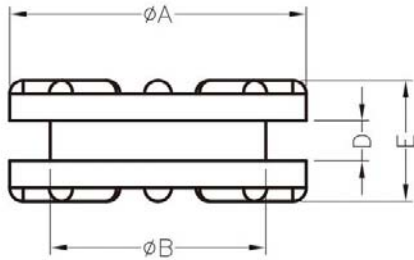

PART NO	A	B	C	D	E	PACKAGE
LTGM56	11.0	8.0	4.4	1.5	4.5	1000

南京诺金电气有限公司

Nanjing Nowking Electric Co., Ltd

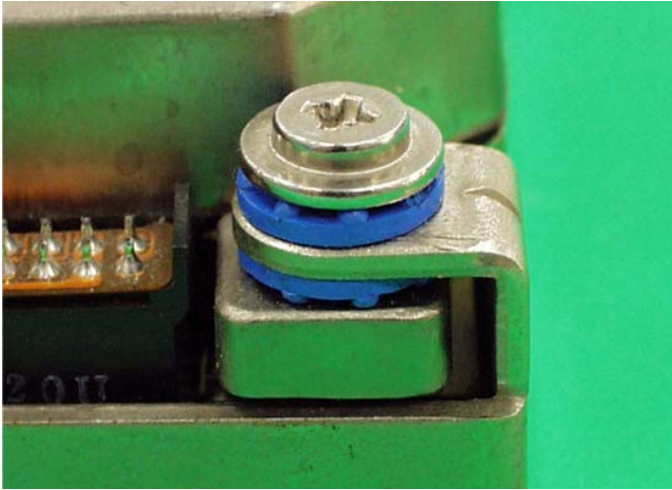

产品名称：抗震线环

规格型号：LTGM57

◆ MATERIAL:TPE

◆ COLOR:BLACK

◆ UNIT: mm

用途：用于硬盘及精密零件之防震。

G:为 45 度硬度 H:为 55 度硬度

LTGM57 结构图

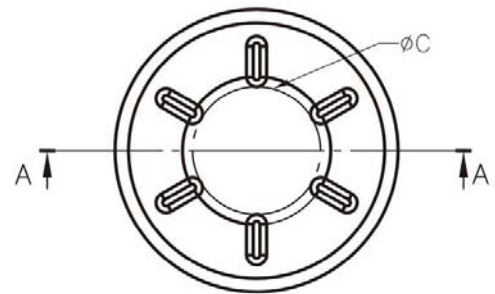
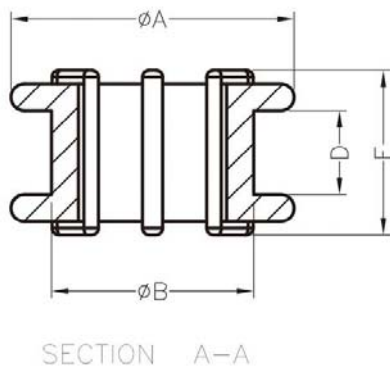

PART NO	A	B	C	D	E	PACKAGE
LTGM57	8.4	6.0	3.8	2.5	4.9	1000

南京诺金电气有限公司

Nanjing Nowking Electric Co., Ltd

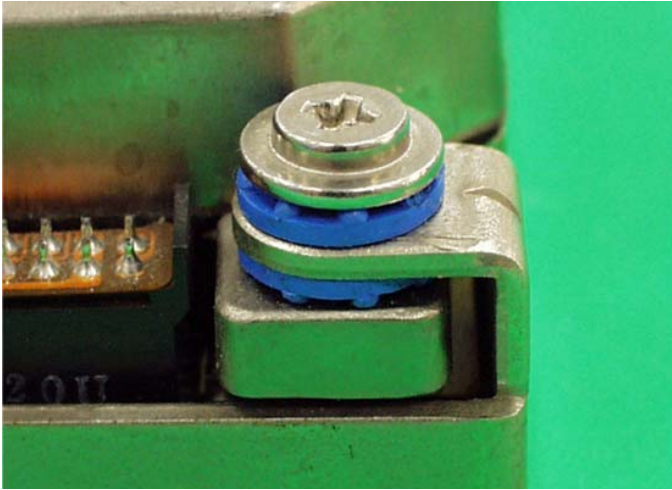

产品名称：抗震线环

规格型号：LTGM58

◆ MATERIAL:TPE

◆ COLOR:BLACK

◆ UNIT: mm

用途：用于硬盘及精密零件之防震。

G:为 45 度硬度 H:为 55 度硬度

LTGM58 结构图

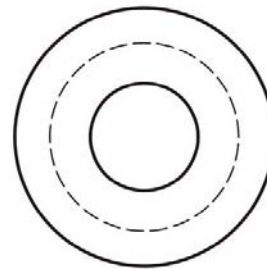
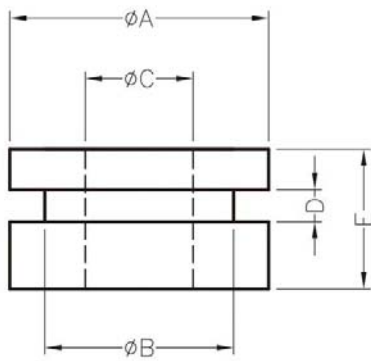

PART NO	A	B	C	D	E	PACKAGE
LTGM58	9.6	7.0	4.0	1.2	5.2	1000

总机/TEL:+86 25 85437901 85422485 85436028
[Http://www.nowking.com](http://www.nowking.com) E-mail: nk@nowking.com
 QQ: 260678075 WeChat:13770725488

南京诺金电气有限公司

Nanjing Nowking Electric Co., Ltd

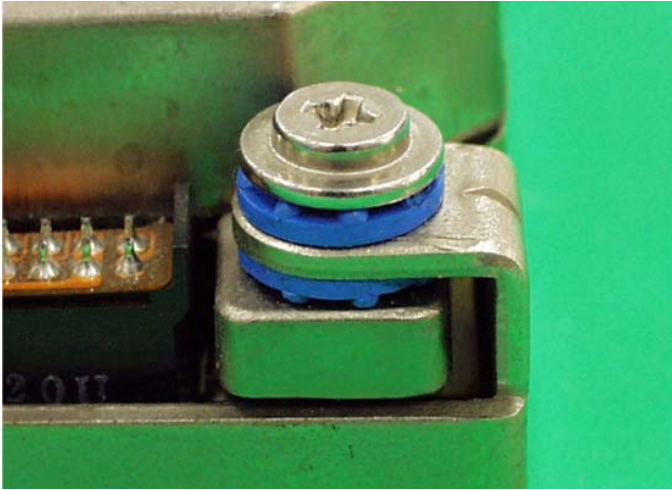

产品名称：抗震线环

规格型号：LTGM59

◆ MATERIAL:TPE

◆ COLOR:BLACK

◆ UNIT: mm

用途：用于硬盘及精密零件之防震。

G:为 45 度硬度 H:为 55 度硬度

LTGM59 结构图

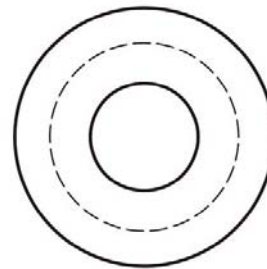
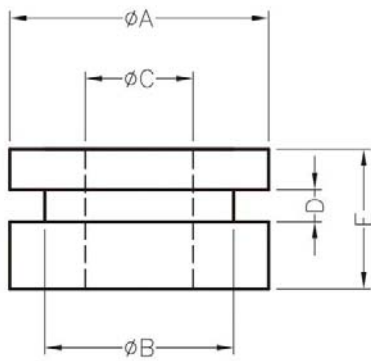

PART NO	A	B	C	D	E	PACKAGE
LTGM59	8.0	6.0	4.2	0.8	2.9	1000

总机/TEL:+86 25 85437901 85422485 85436028
[Http://www.nowking.com](http://www.nowking.com) E-mail: nk@nowking.com
 QQ: 260678075 WeChat:13770725488

南京诺金电气有限公司

Nanjing Nowking Electric Co., Ltd

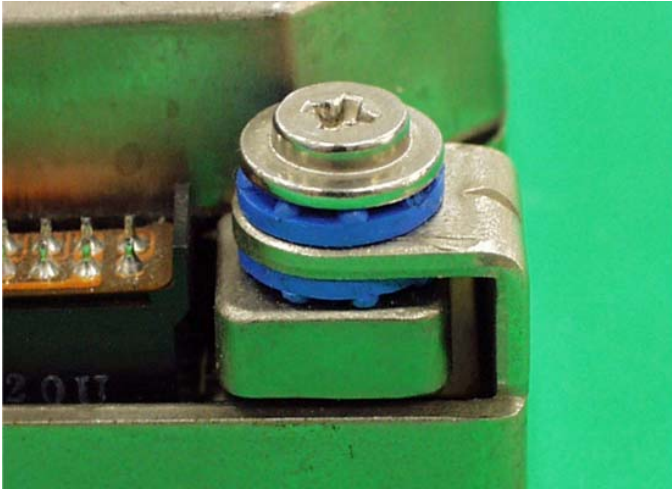

产品名称：抗震线环

规格型号：LTGM60

◆ MATERIAL:TPE

◆ COLOR:BLUE

◆ UNIT: mm

用途：用于硬盘及精密零件之防震。

G:为 45 度硬度 H:为 55 度硬度

LTGM60 结构图

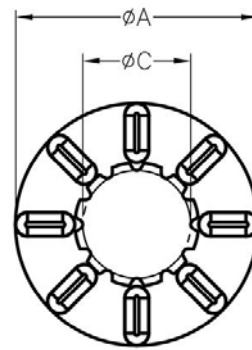
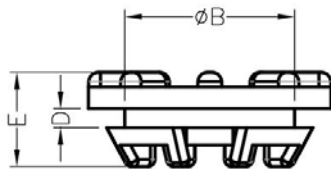

PART NO	A	B	C	D	E	PACKAGE
LTGM60	10.0	7.0	4.45	0.8	3.9	1000

南京诺金电气有限公司

Nanjing Nowking Electric Co., Ltd

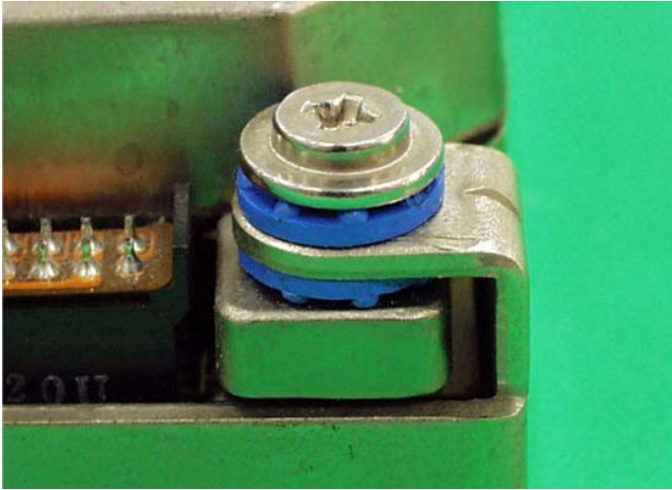

产品名称：抗震线环

规格型号：LTGM61

◆ MATERIAL:TPE

◆ COLOR:BLACK

◆ UNIT: mm

用途：用于硬盘及精密零件之防震。

G:为 45 度硬度 H:为 55 度硬度

LTGM61 结构图

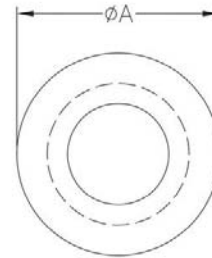
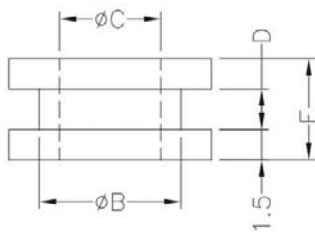

PART NO	A	B	C	D	E	PACKAGE
LTGM61	Ø10.0	Ø7.0	Ø5.0	2.0	5.0	1000

南京诺金电气有限公司

Nanjing Nowking Electric Co., Ltd



产品名称：抗震线环

规格型号：LTGM62

- ◆ MATERIAL:TPE
- ◆ COLOR:BLACK,BLUE
- ◆ MATERIAL:ZINC PALTED STEEL
- ◆ UNIT: mm

用途：用于硬盘及精密零件之防震。

H:为 55 度硬度 G:为 45 度硬度.

MATERIAL 2 为插稍材质

LTGM62 结构图

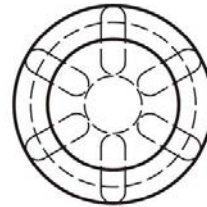
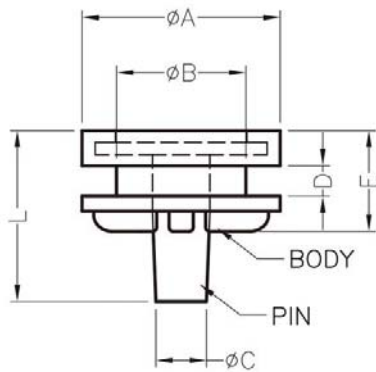

PART NO	A	B	C	D	E	L	PACKAGE
LTGM62	Ø9.8	Ø6.4	Ø2.5	1.5	5.5	9.0	1000

南京诺金电气有限公司

Nanjing Nowking Electric Co., Ltd



产品名称：抗震线环

规格型号：LTGM63

- ◆ MATERIAL:TPE
- ◆ COLOR:BLACK,BLUE
- ◆ MATERIAL:ZINC PALTED STEEL
- ◆ UNIT: mm

用途：用于硬盘及精密零件之防震。

MATERIAL 2 为插稍材质

LTGM63 结构图

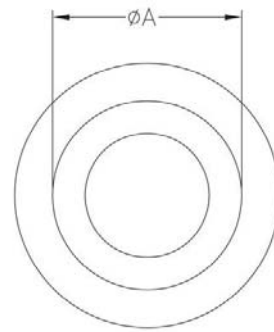
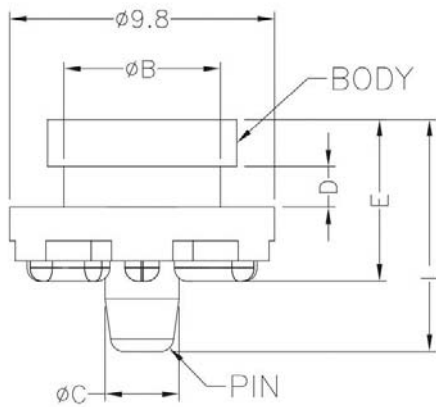

PART NO	A	B	C	D	E	L	PACKAGE
LTGM63	$\phi 7.0$	$\phi 5.8$	$\phi 2.74$	1.5	6.0	8.15	1000

南京诺金电气有限公司

Nanjing Nowking Electric Co., Ltd



产品名称：抗震线环

规格型号：LTGM64

◆MATERIAL:NBR,BUBBER,SILICON
BUBBER

◆COLOR:BLACK

◆UNIT: mm

用途：用于硬盘及精密零件之防震。

LTGM64 结构图

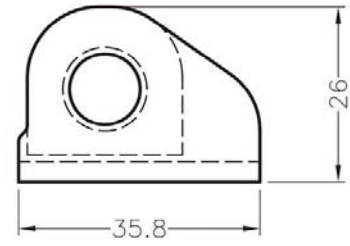
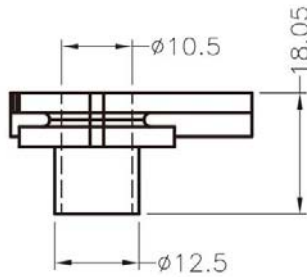

	PART NO	PACKAGE
	LTGM64	1000

南京诺金电气有限公司

Nanjing Nowking Electric Co., Ltd



产品名称：抗震线环

规格型号：LTGM65

◆MATERIAL:NBR,BUBBER,SILICON
BUBBER

◆COLOR:BLACK

◆UNIT: mm

用途：用于硬盘及精密零件之防震。

LTGM65 结构图

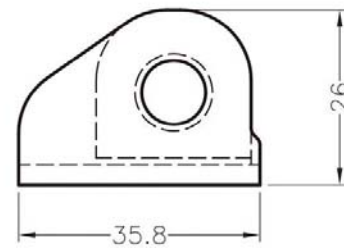
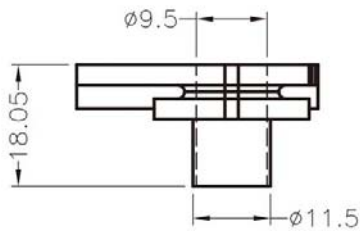

PART NO	PACKAGE
LTGM65	1000

南京诺金电气有限公司

Nanjing Nowking Electric Co., Ltd



产品名称：抗震线环

规格型号：LTGM66

◆MATERIAL:NBR,BUBBER,SILICON
BUBBER

◆COLOR:BLACK

◆UNIT: mm

用途：用于硬盘及精密零件之防震。

LTGM66 结构图

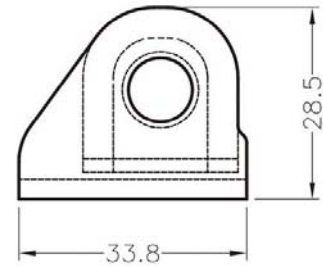
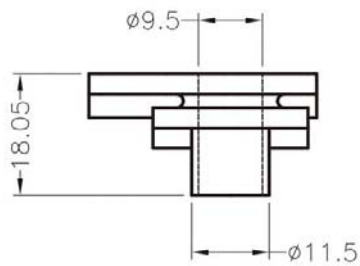

PART NO	PACKAGE
LTGM66	1000

南京诺金电气有限公司

Nanjing Nowking Electric Co., Ltd



产品名称：抗震线环

规格型号：LTGM67

◆MATERIAL:NBR,BUBBER,SILICON
BUBBER

◆COLOR:BLACK

◆UNIT: mm

用途：用于硬盘及精密零件之防震。

LTGM67 结构图

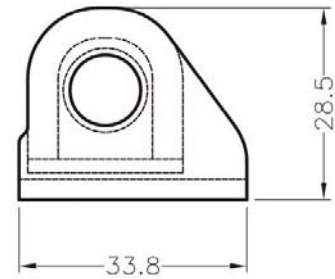
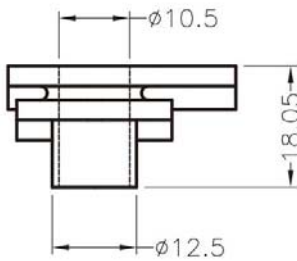

PART NO	PACKAGE
LTGM67	1000

南京诺金电气有限公司

Nanjing Nowking Electric Co., Ltd

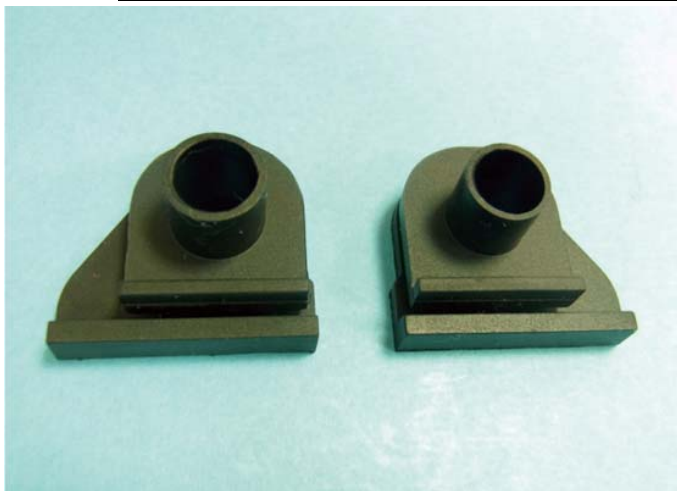

产品名称：抗震线环

规格型号：LTGM68

◆MATERIAL:NBR,BUBBER,SILICON
BUBBER

◆COLOR:BLACK

◆UNIT: mm

用途：用于硬盘及精密零件之防震。

LTGM68 结构图

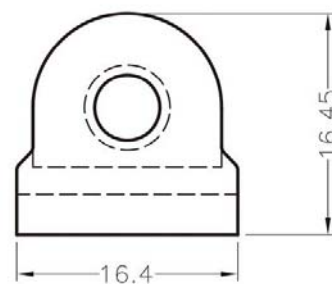
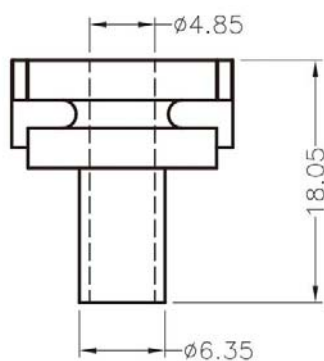

PART NO	PACKAGE
LTGM68	1000

南京诺金电气有限公司

Nanjing Nowking Electric Co., Ltd



产品名称：抗震线环

规格型号：LTGM69

◆MATERIAL:NBR,BUBBER,SILICON
BUBBER

◆COLOR:BLACK

◆UNIT: mm

用途：用于硬盘及精密零件之防震。

LTGM69 结构图

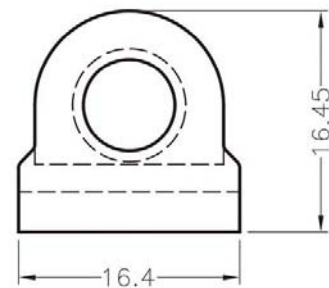
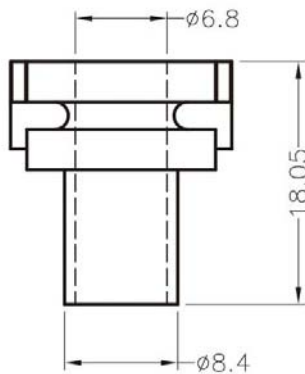

PART NO	PACKAGE
LTGM69	1000

南京诺金电气有限公司

Nanjing Nowking Electric Co., Ltd



产品名称: 抗震线环

规格型号: LTGM70

◆ MATERIAL: NBR, BUBBER, SILICON
BUBBER

◆ COLOR: BLACK

◆ UNIT: mm

用途: 用于硬盘及精密零件之防震。

LTGM70 结构图

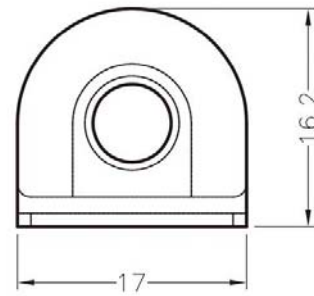
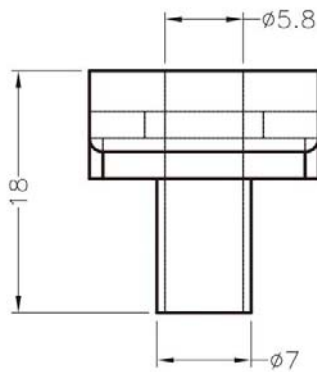

PART NO	PACKAGE
LTGM70	1000

南京诺金电气有限公司

Nanjing Nowking Electric Co., Ltd



产品名称：抗震线环

规格型号：LTGM71

◆MATERIAL:NBR,BUBBER,SILICON
BUBBER

◆COLOR:BLACK

◆UNIT: mm

用途：用于硬盘及精密零件之防震。

LTGM71 结构图

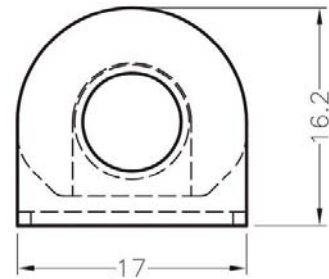
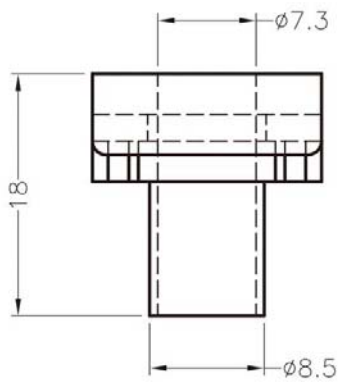

PART NO	PACKAGE
LTGM71	1000

南京诺金电气有限公司

Nanjing Nowking Electric Co., Ltd



产品名称：抗震线环

规格型号：LTGM72

◆MATERIAL:TPR

◆COLOR:BLACK

◆UNIT: mm

用途：用于硬盘及精密零件之防震。

LTGM72 结构图

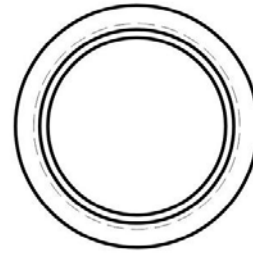
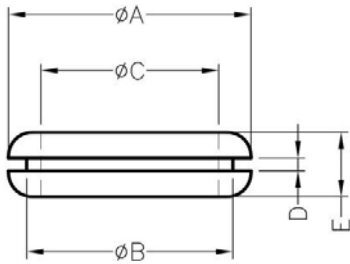

PART NO	A	B	C	D	E	PACKAGE
LTGM72	30.0	25.5	22.0	1.6	8.0	1000

南京诺金电气有限公司

Nanjing Nowking Electric Co., Ltd



产品名称：抗震线环

规格型号：LTGM73

◆ MATERIAL: RUBBER

◆ COLOR: BLACK

◆ UNIT: mm

用途：用于硬盘及精密零件之防震。

LTGM73 结构图

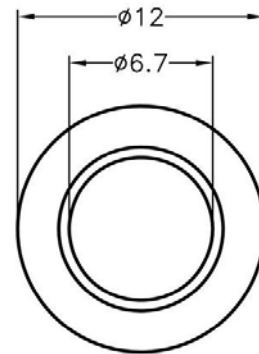
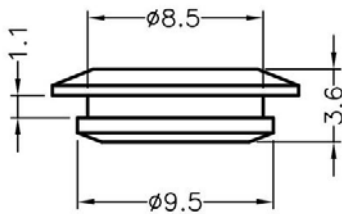

PART NO	A	B	D	E	F	PACKAGE
LTGM73	Ø12.0	Ø8.5	1.1	3.6	Ø9.5	1000

南京诺金电气有限公司

Nanjing Nowking Electric Co., Ltd



产品名称: 抗震线环

规格型号: LTGM74

◆ MATERIAL 1: TPE

◆ COLOR: BLACK

◆ MATERIAL 2: ZINC PLATED STEEL

◆ UNIT: mm

用途: 用于硬盘及精密零件之防震。

1. 所有尺寸量测皆不含进胶口, 胶口凸出

1.2mm 之内.

2. 可使用同等材质

LTGM74 结构图

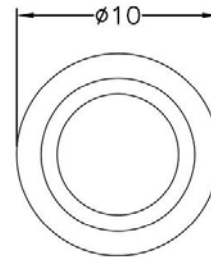
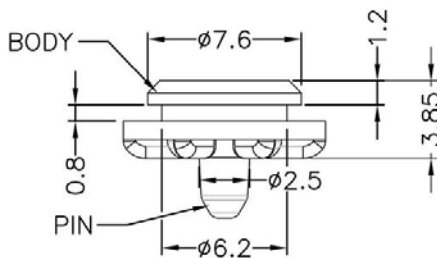

PART NO	PACKAGE
LTGM74	1000

南京诺金电气有限公司

Nanjing Nowking Electric Co., Ltd



产品名称：抗震线环

规格型号：LTGM75

- ◆ MATERIAL 1: TPE(UL)
- ◆ FALME CLASS :94V-0
- ◆ COLOR:BLACK
- ◆ UNIT: mm

用途：用于硬盘及精密零件之防震。

- 1.所有尺寸量测皆不含进胶口,胶口凸出1.2mm 之内.
- 2.可使用同等材质

LTGM75 结构图

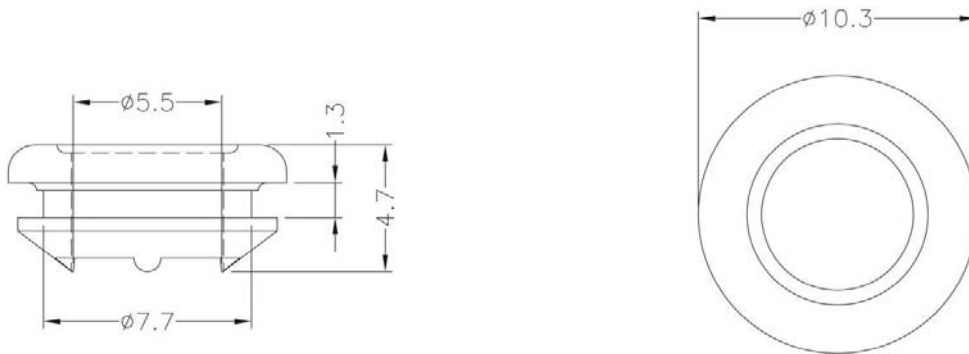

PART NO	PACKAGE
LTGM75	1000

南京诺金电气有限公司

Nanjing Nowking Electric Co., Ltd



产品名称：抗震线环

规格型号：LTGM76

◆ MATERIAL:TPE

◆ COLOR:BLUE

◆ MATERIAL 2: STEEL

◆ UNIT: mm

用途：用于硬盘及精密零件之防震。

MATERIAL 2 为螺丝材质

LTGM76 结构图

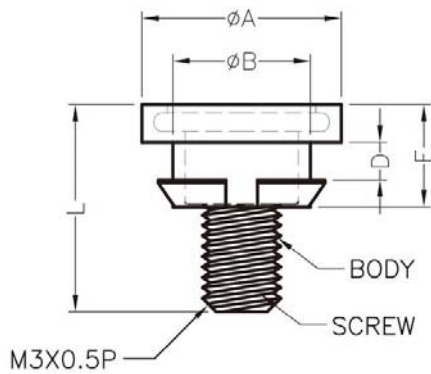

PART NO	A	B	C	D	E	L	PACKAGE
LTGM76	Ø7.4	Ø5.1	1.4	3.8	Ø3.5	7.7	1000

南京诺金电气有限公司

Nanjing Nowking Electric Co., Ltd

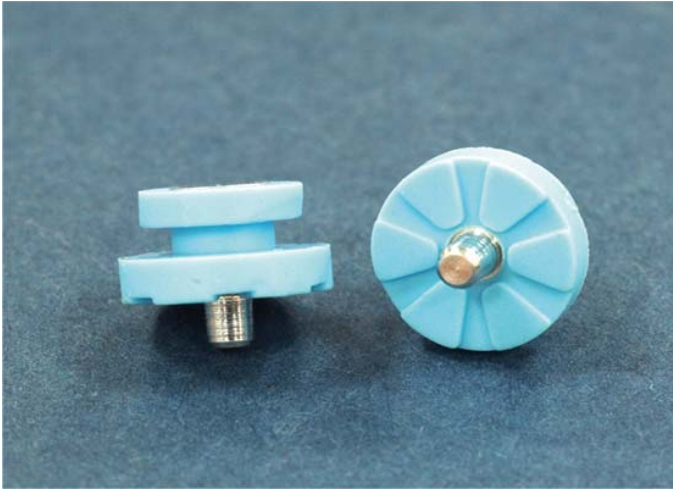

产品名称：抗震线环

规格型号：LTGM77

◆ MATERIAL:TPE

◆ COLOR:BLUE

◆ MATERIAL 2: ZINC PLATED STEEL

◆ UNIT: mm

用途：用于硬盘及精密零件之防震。

可使用同等材质

LTGM77 结构图

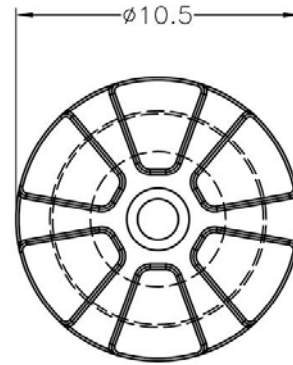
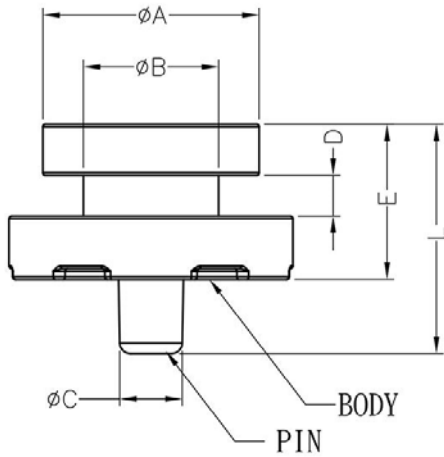

PART NO	A	B	C	D	E	L	PACKAGE
LTGM77	Ø8.0	Ø5.0	Ø2.31	1.5	5.75	8.5	1000

南京诺金电气有限公司

Nanjing Nowking Electric Co., Ltd



产品名称：抗震线环

规格型号：LTGM78

- ◆ MATERIAL:TPE
- ◆ COLOR:BLUE,BLACK
- ◆ MATERIAL 2: ZINC PLATED STEEL
- ◆ UNIT: mm

用途：用于硬盘及精密零件之防震。

MATERIAL 2 为插梢材质

专利品 P.A.T

LTGM78 结构图

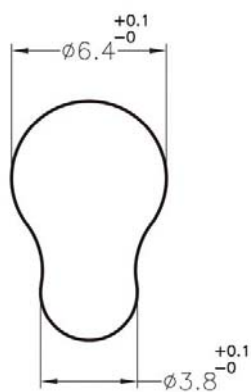
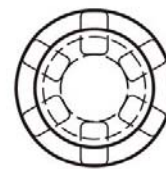
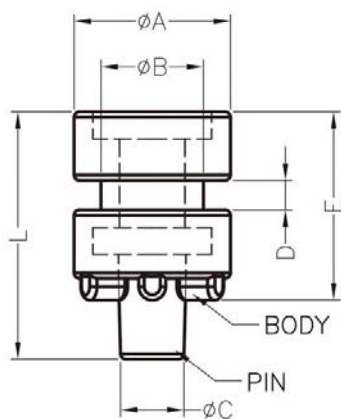

MOUNTING HOLE

PART NO	A	B	C	D	E	L	PACKAGE
LTGM78	$\phi 5.8$	$\phi 3.8$	$\phi 2.35$	1.1	7.0	9.2	1000

总机/TEL:+86 25 85437901 85422485 85436028
[Http://www.nowking.com](http://www.nowking.com) E-mail: nk@nowking.com
 QQ: 260678075 WeChat:13770725488

南京诺金电气有限公司

Nanjing Nowking Electric Co., Ltd

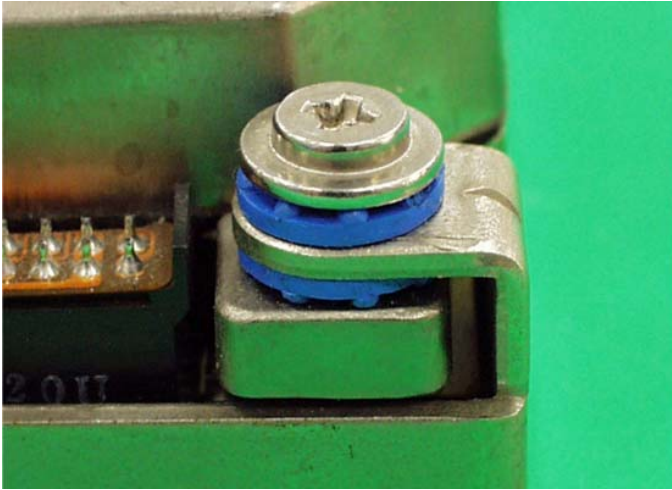

产品名称：抗震线环

规格型号：LTGM79

◆ MATERIAL:TPE

◆ COLOR:BLACK

◆ UNIT: mm

用途：用于硬盘及精密零件之防震。

H:为 55 度硬度 G:为 45 度硬度.

LTGM79 结构图

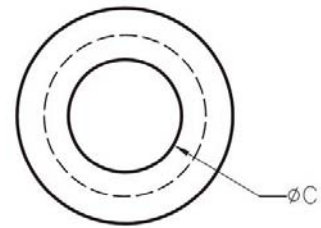
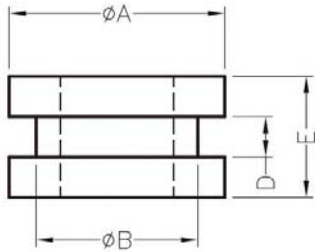

PART NO	A	B	C	D	E	PACKAGE
LTGM79	Ø8.8	Ø6.6	Ø3.6	0.8	3.8	1000

南京诺金电气有限公司

Nanjing Nowking Electric Co., Ltd

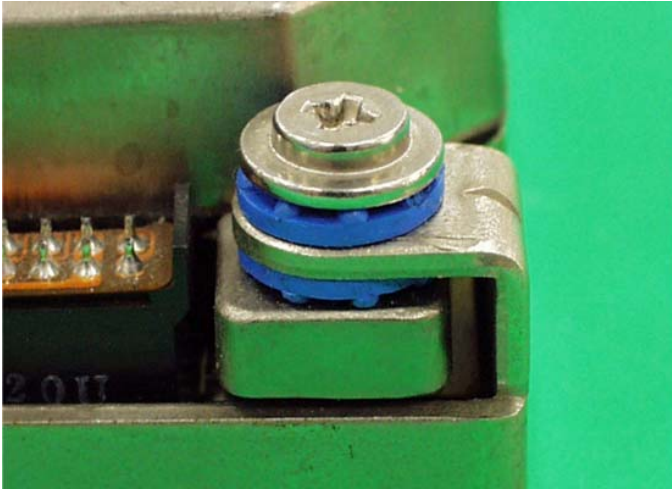

产品名称：抗震线环

规格型号：LTGM80

◆ MATERIAL:TPE

◆ COLOR:BLACK,

◆ UNIT: mm

用途：用于硬盘及精密零件之防震。

H:为 55 度硬度 G:为 45 度硬度.

LTGM80 结构图

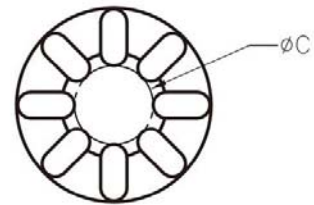
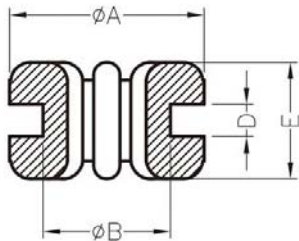

PART NO	A	B	C	D	E	PACKAGE
LTGM80	Ø9.0	Ø6.0	Ø4.0	1.3	3.7	1000

南京诺金电气有限公司

Nanjing Nowking Electric Co., Ltd

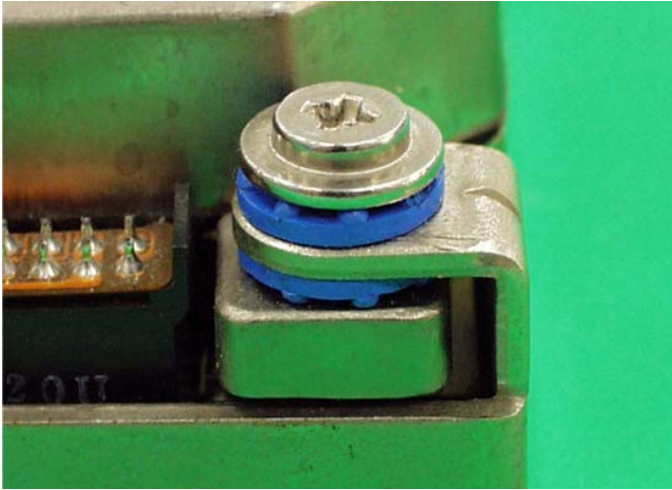

产品名称：抗震线环

规格型号：LTGM81

◆MATERIAL:TPE

◆COLOR:BLACK

◆UNIT: mm

用途：用于硬盘及精密零件之防震。

H:为 55 度硬度 G:为 45 度硬度.

LTGM81 结构图

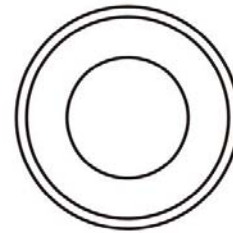
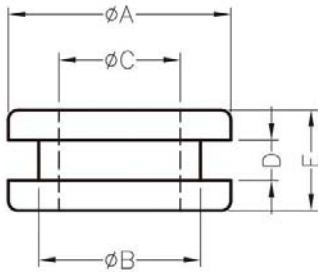

PART NO	A	B	C	D	E	PACKAGE
LTGM81	Ø14.2	Ø9.5	Ø5.4	1.0	4.9	1000

南京诺金电气有限公司

Nanjing Nowking Electric Co., Ltd

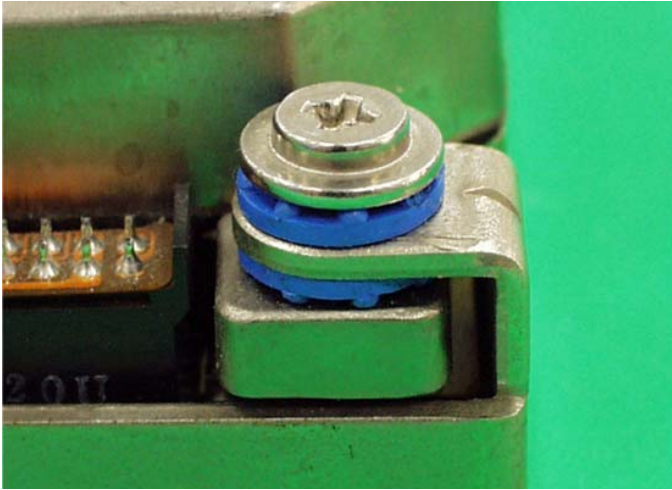

产品名称：抗震线环

规格型号：LTGM82

◆ MATERIAL: TPE

◆ COLOR: BLACK, BLUE, PURPLE, YELLOW

◆ UNIT: mm

用途：用于硬盘及精密零件之防震。

H: 为 55 度硬度 G: 为 45 度硬度.

LTGM82 结构图

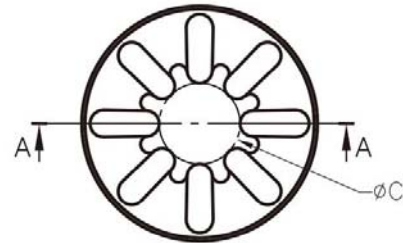
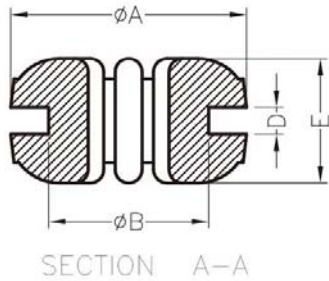

PART NO	A	B	C	D	E	PACKAGE
LTGM82	Ø14.3	Ø9.52	Ø4.78	1.65	8.2	1000

总机/TEL: +86 25 85437901 85422485 85436028
[Http://www.nowking.com](http://www.nowking.com) E-mail: nk@nowking.com
 QQ: 260678075 WeChat: 13770725488

南京诺金电气有限公司

Nanjing Nowking Electric Co., Ltd



产品名称：抗震线环

规格型号：LTGM83

◆ MATERIAL 1: SILICON RUBBER

◆ FALME CLASS :94V-0

◆ COLOR:BLACK,BLUE

◆ UNIT: mm

用途：用于硬盘及精密零件之防震。

LTGM83 结构图

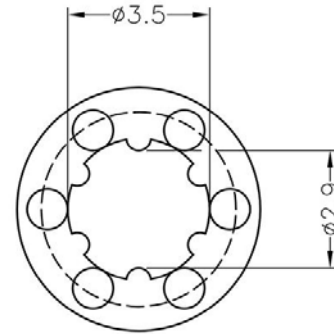
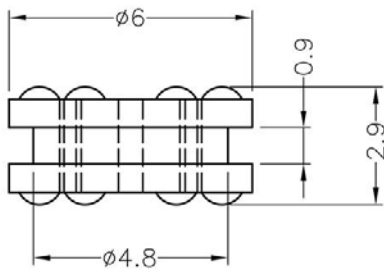

	PART NO	PACKAGE
	LTGM83	1000

南京诺金电气有限公司

Nanjing Nowking Electric Co., Ltd



产品名称：抗震线环

规格型号：LTGM84

◆ MATERIAL: SILICON RUBBER

◆ COLOR: BLACK

◆ UNIT: mm

用途：用于硬盘及精密零件之防震。

LTGM84 结构图

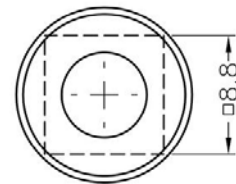
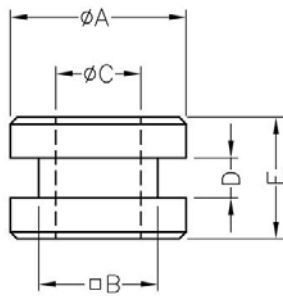

PART NO	A	B	C	D	E	PACKAGE
LTGM84	13.0	8.8	6.3	3.0	9.0	1000

南京诺金电气有限公司

Nanjing Nowking Electric Co., Ltd



产品名称：抗震线环

规格型号：LTGM85

◆MATERIAL: RUBBER, SILICON
RUBBER

◆COLOR: BLACK

◆UNIT: mm

用途：用于硬盘及精密零件之防震。

LTGM85 结构图

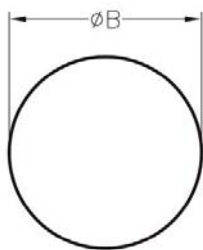
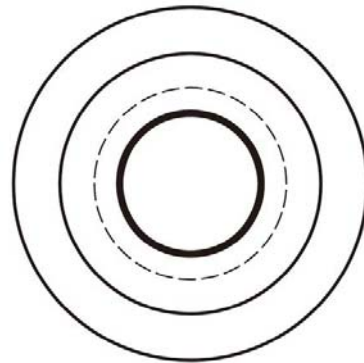
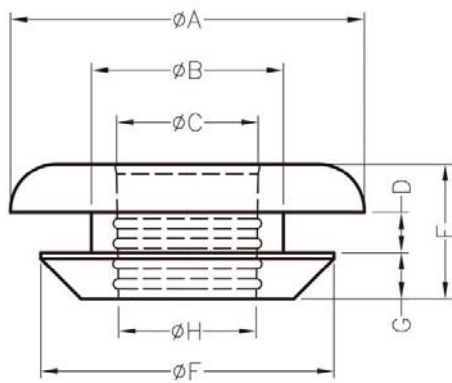

MOUNTING HOLES

PART NO	A	B	C	D	E	F	G	H	PACKAGE
LTGM85	21.8	13.8	11.2	2.0	6.7	18.8	2.3	10.8	1000

总机/TEL: +86 25 85437901 85422485 85436028
[Http://www.nowking.com](http://www.nowking.com) E-mail: nk@nowking.com
 QQ: 260678075 WeChat: 13770725488

南京诺金电气有限公司

Nanjing Nowking Electric Co., Ltd



产品名称：抗震线环

规格型号：LTGM86

- ◆ MATERIAL 1: PC(UL)
- ◆ FALME CLASS :94V-0
- ◆ COLOR:BLACK
- ◆ UNIT: mm

用途：硬盘及精密零件之抗震线还用螺丝，可配合抗震线环使用。 可配合抗震线环 LTGM82 使用。

LTGM86 结构图

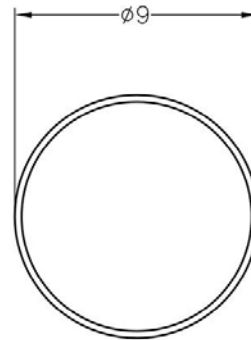
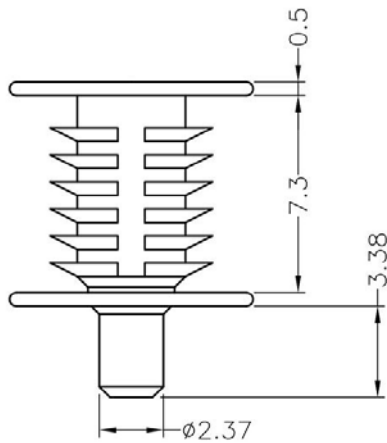

PART NO	PACKAGE
LTGM86	1000